

TIP31/31A/31B/31C

SemiHow
Know-How for Semiconductor

TIP31/31A/31B/31C

Medium Power Linear Switching Applications

- Complement to TIP32/32A/32B/32C

Absolute Maximum Ratings $T_a=25^\circ\text{C}$ unless otherwise noted

CHARACTERISTICS	SYMBOL	RATING	UNIT
Collector-Base Voltage : TIP31	V_{CBO}	40	V
: TIP31A		60	V
: TIP31B		80	V
: TIP31C		100	V
Collector-Emitter Voltage : TIP31	V_{CEO}	40	V
: TIP31A		60	V
: TIP31B		80	V
: TIP31C		100	V
Emitter-Base Voltage	V_{EBO}	5	V
Collector Current(DC)	I_C	3	A
Collector Current(Pulse)	I_{CP}	5	A
Base Current	I_B	1	A
Collector Dissipation($T_a=25^\circ\text{C}$)	P_C	2	W
Collector Dissipation($T_c=25^\circ\text{C}$)	P_C	40	W
Junction Temperature	T_J	150	$^\circ\text{C}$
Storage Temperature	T_{STG}	-65~150	$^\circ\text{C}$

PNP Epitaxial Silicon Darlington Transistor

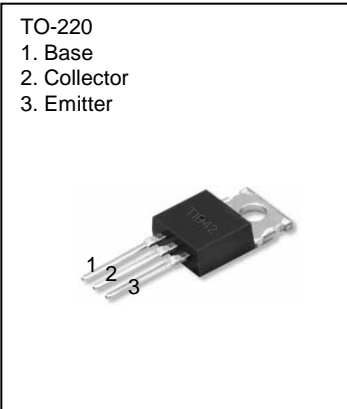

- TO-220
1. Base
2. Collector
3. Emitter

Electrical Characteristics $T_a=25^\circ\text{C}$ unless otherwise noted

CHARACTERISTICS	SYMBOL	Test Condition	Min	Max	Unit		
Collector-Emitter Sustaining Voltage : TIP31 : TIP31A : TIP31B : TIP31C	$V_{CEO(SUS)}$	$I_C=30\text{mA}, I_B=0$	40		V		
			60		V		
			80		V		
			100		V		
Collector Cut-off Current : TIP31/31A : TIP31B/31C	I_{CEO}	$V_{CE}=30\text{V}, I_B=0$		0.3	mA		
		$V_{CE}=60\text{V}, I_B=0$		0.3	mA		
Collector Cut-off Current : TIP31 : TIP31A : TIP31B : TIP31C	I_{CES}	$V_{CE}=40\text{V}, V_{EB}=0$ $V_{CE}=60\text{V}, V_{EB}=0$ $V_{CE}=80\text{V}, V_{EB}=0$ $V_{CE}=100\text{V}, V_{EB}=0$		200	μA		
					200	μA	
						200	μA
						200	μA
Emitter Cut-off Current	I_{EBO}	$V_{EB}=5\text{V}, I_C=0$		1	mA		
*DC Current Gain	h_{FE}	$V_{CE}=4\text{V}, I_C=1\text{A}$	25				
		$V_{CE}=4\text{V}, I_C=3\text{A}$	10	50			
*Collector-Emitter Saturation Voltage	$V_{CE(sat)}$	$I_C=3\text{A}, I_B=375\text{mA}$		1.2	V		
*Base-Emitter ON Voltage	$V_{BE(on)}$	$V_{CE}=4\text{V}, I_C=3\text{A}$		1.8	V		
Output Capacitance	f_T	$V_{CE}=10\text{V}, I_C=500\text{mA}, f=1\text{MHz}$	3.0		MHz		

* Pulse Test: $PW \leq 300\mu\text{s}$, Duty Cycle $\leq 2\%$

Typical Characteristics

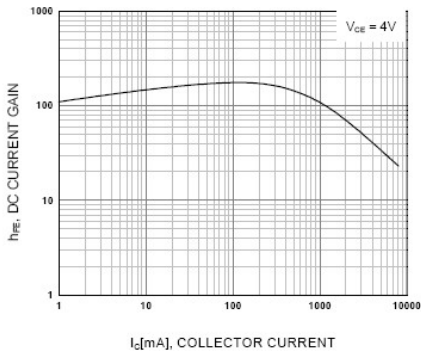

Figure 1. DC current Gain

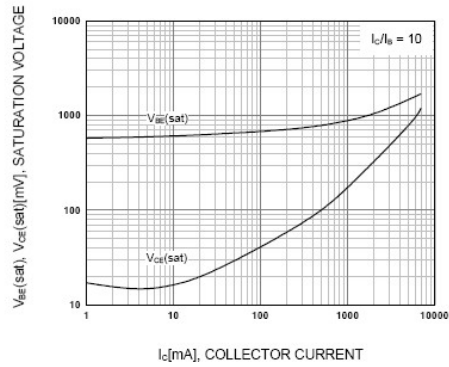

Figure 2. Base-Emitter Saturation Voltage
Collector-Emitter Saturation Voltage

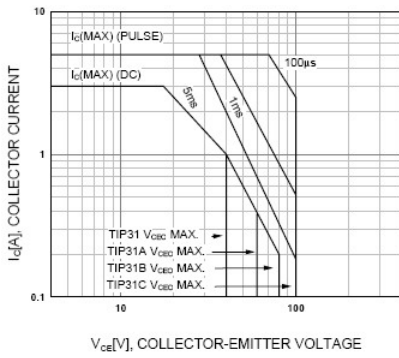

Figure 3. Safe Operating Area

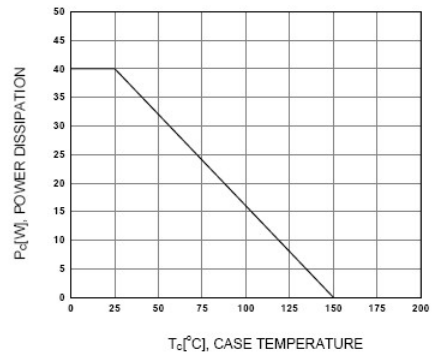
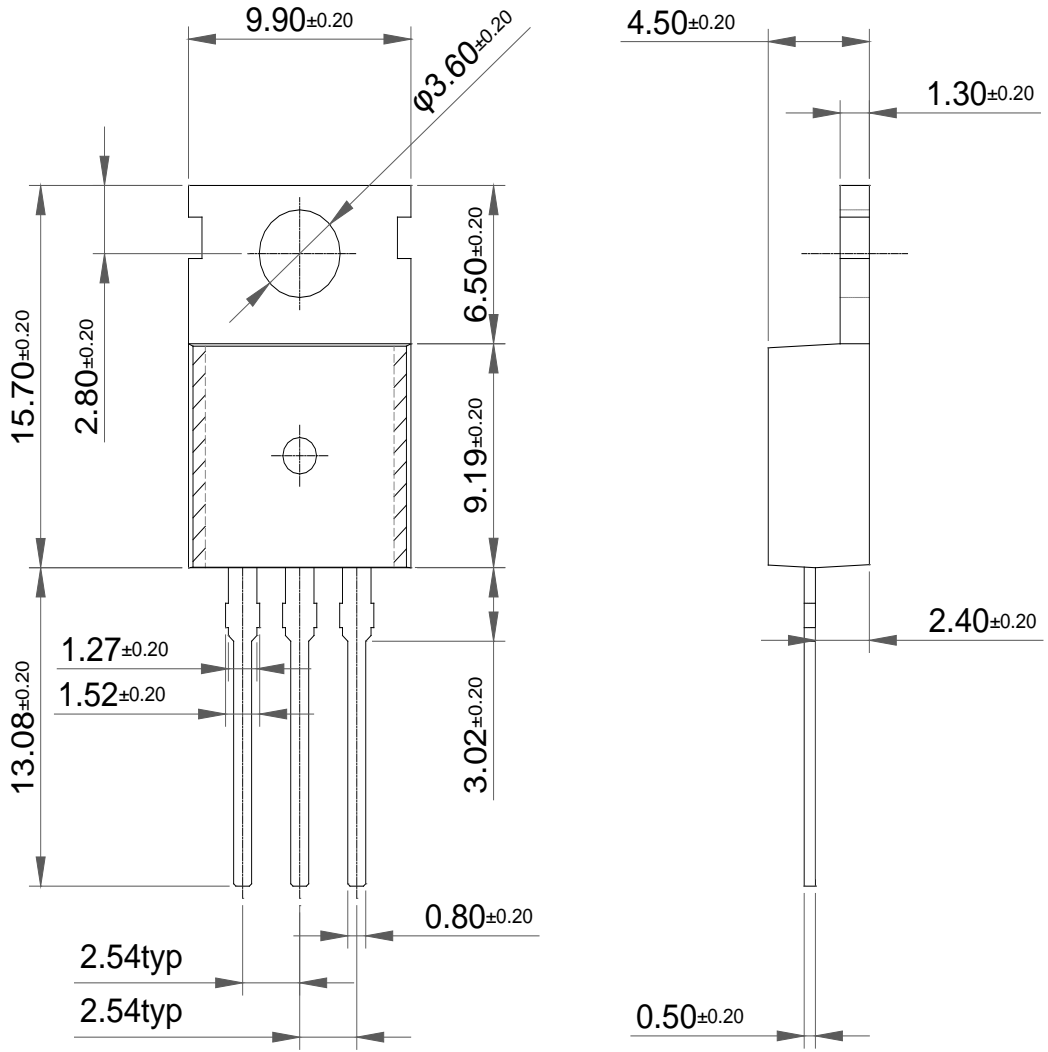

Figure 4. Power Derating

Package Dimension

TO-220 (A)



Dimensions in Millimeters

Package Dimension

TO-220 (B)

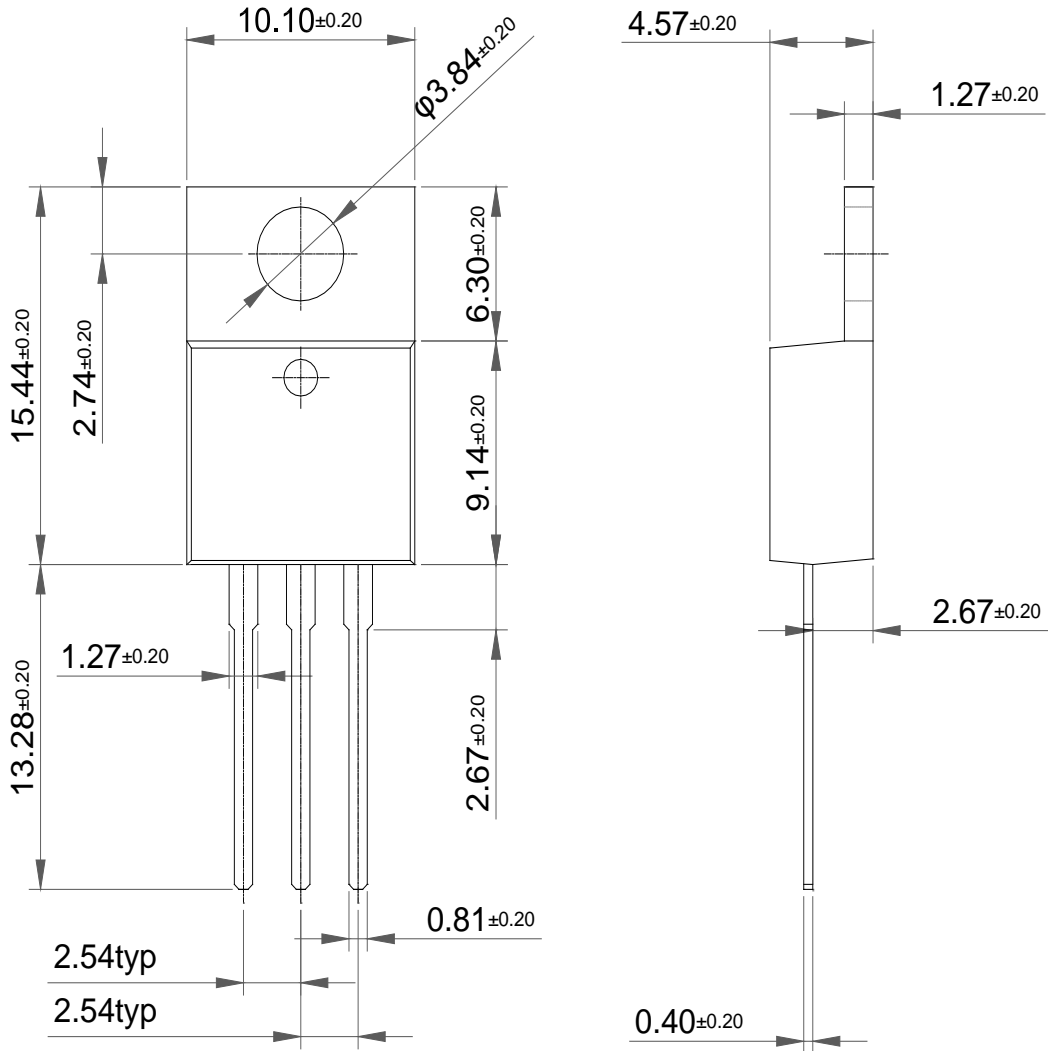

Dimensions in Millimeters