

TIP140T/141T/142T

SemiHow
Know-How for Semiconductor

TIP140T/141T/142T

Monolithic Construction With Built In Base-Emitter Shunt Resistors

- High DC Current Gain : $h_{FE}=1000$ @ $V_{CE}=2V, I_C=5A$ (Min.)
- Collector-Emitter Sustaining Voltage
- Low Collector-Emitter Saturation Voltage
- Industrial Use
- Complementary to TIP145/146/147

Absolute Maximum Ratings $T_a=25^\circ\text{C}$ unless otherwise noted

CHARACTERISTICS	SYMBOL	RATING	UNIT
Collector-Base Voltage : TIP140T : TIP141T : TIP142T	V_{CBO}	60 80 100	V V V
Collector-Emitter Voltage : TIP140T : TIP141T : TIP142T	V_{CEO}	60 80 100	V V V
Emitter-Base Voltage	V_{EBO}	5	V
Collector Current(DC)	I_C	10	A
Collector Current(Pulse)	I_{CP}	15	A
Base Current	I_B	0.5	A
Collector Dissipation($T_a=25^\circ\text{C}$)	P_C	2	W
Collector Dissipation($T_c=25^\circ\text{C}$)	P_C	80	W
Junction Temperature	T_J	150	$^\circ\text{C}$
Storage Temperature	T_{STG}	-65~150	$^\circ\text{C}$

PNP Epitaxial Silicon Darlington Transistor

Equivalent Circuit

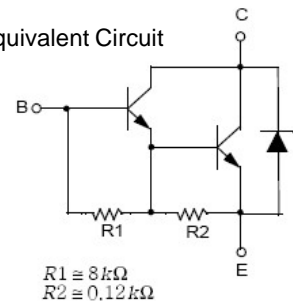

TO-220

1. Base
2. Collector
3. Emitter



Electrical Characteristics $T_a=25^\circ\text{C}$ unless otherwise noted

CHARACTERISTICS	SYMBOL	Test Condition	Min	Max	Unit
Collector-Emitter Sustaining Voltage : TIP140T : TIP141T : TIP142T	$V_{CEO(SUS)}$	$I_C=30\text{mA}, I_B=0$	60 80 100		V V V
Collector Cut-off Current : TIP140T : TIP141T : TIP142T	I_{CEO}	$V_{CE}=30\text{V}, I_B=0$ $V_{CE}=40\text{V}, I_B=0$ $V_{CE}=50\text{V}, I_B=0$		2 2 2	mA mA mA
Collector Cut-off Current : TIP140T : TIP141T : TIP142T	I_{CBO}	$V_{CE}=60\text{V}, I_E=0$ $V_{CE}=80\text{V}, I_E=0$ $V_{CE}=100\text{V}, I_E=0$		1 1 1	mA mA mA
Emitter Cut-off Current	I_{EBO}	$V_{EB}=5\text{V}, I_C=0$		2	mA
DC Current Gain	h_{FE}	$V_{CE}=4\text{V}, I_C=5\text{A}$ $V_{CE}=4\text{V}, I_C=10\text{A}$	1000 500		
Collector-Emitter Saturation Voltage	$V_{CE(sat)}$	$I_C=5\text{A}, I_B=10\text{mA}$ $I_C=10\text{A}, I_B=40\text{mA}$		2 3	V V
Base-Emitter ON Voltage	$V_{BE(on)}$	$V_{CE}=4\text{V}, I_C=10\text{A}$		3	V
Output Capacitance	C_{ob}	$V_{CB}=10\text{V}, I_E=0, f=0.1\text{MHz}$		200	pF

* Pulse Test: $PW \leq 300\mu\text{s}$, Duty Cycle $\leq 2\%$

Typical Characteristics

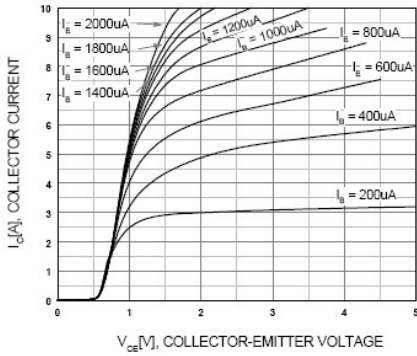

Figure 1. Static Characteristic

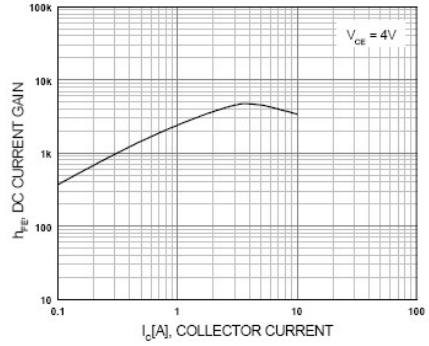

Figure 2. DC current Gain

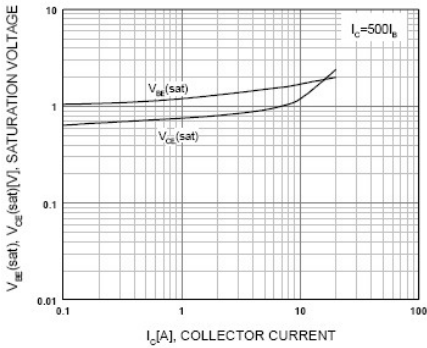

Figure 3. Collector-Emitter Saturation Voltage
Base-Emitter Saturation Voltage

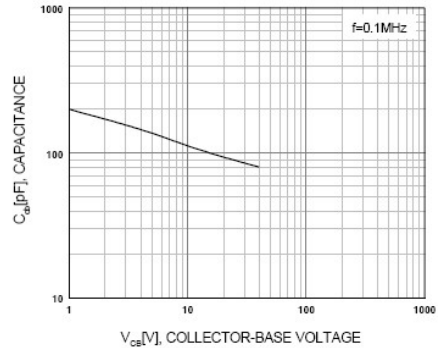

Figure 4. Collector Output Capacitance

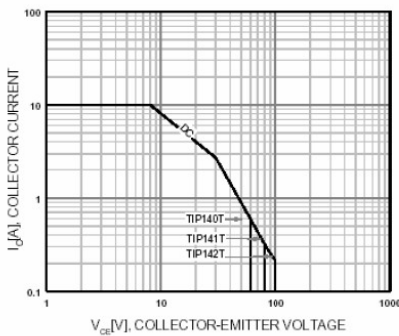

Figure 5. Safe Operating Area

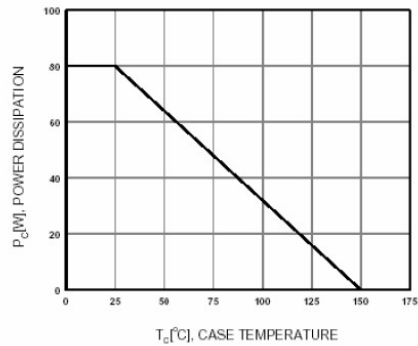
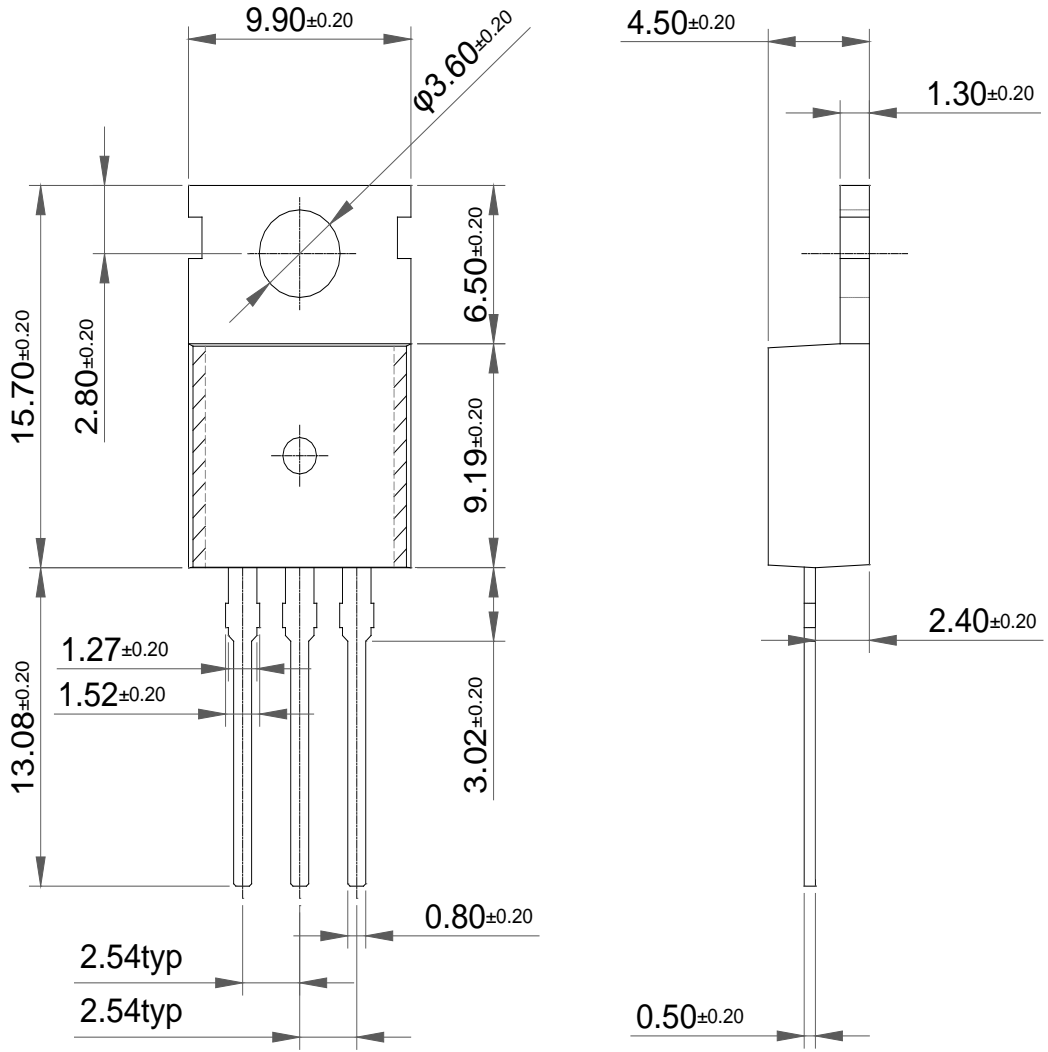

Figure 6. Power Derating

Package Dimension

TO-220 (A)



Dimensions in Millimeters

Package Dimension

TO-220 (B)

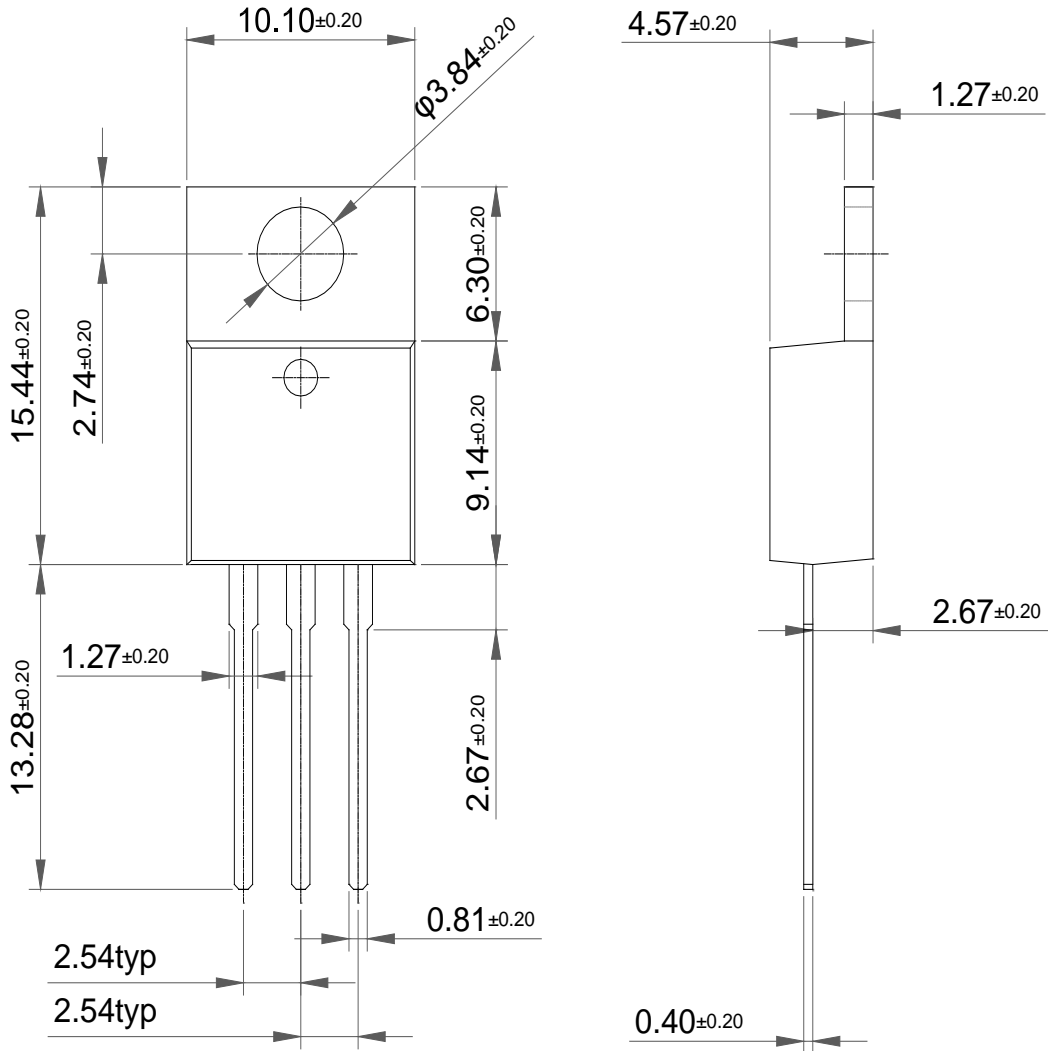

Dimensions in Millimeters