

# HFP630A / HFS630A

## 200V N-Channel MOSFET

### Features

- Superior Avalanche Rugged Technology
- Robust Gate Oxide Technology
- Very Low Intrinsic Capacitances
- Excellent Switching Characteristics
- 100% Avalanche Tested
- RoHS Compliant

### Key Parameters

Parameter	Value	Unit
$BV_{DSS}$	200	V
$I_D$	9.0	A
$R_{DS(on), Typ}$	0.34	$\Omega$
$Qg, Typ$	12	nC

**HFP630A**  
**TO-220**

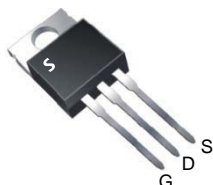

**HFS630A**  
**TO-220F**

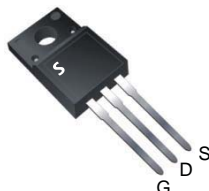

**Symbol**

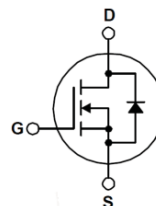

### Absolute Maximum Ratings $T_C=25^\circ\text{C}$ unless otherwise specified

Symbol	Parameter	TO-220	TO-220F	Unit
$V_{DSS}$	Drain-Source Voltage	200		V
$I_D$	Drain Current – Continuous ( $T_C = 25^\circ\text{C}$ )	9.0	9.0 *	A
	Drain Current – Continuous ( $T_C = 100^\circ\text{C}$ )	5.7	5.7 *	A
$I_{DM}$	Drain Current – Pulsed (Note 1)	36	36 *	A
$V_{GS}$	Gate-Source Voltage	$\pm 30$		V
$E_{AS}$	Single Pulsed Avalanche Energy (Note 2)	232		mJ
$I_{AR}$	Avalanche Current (Note 1)	9		A
$E_{AR}$	Repetitive Avalanche Energy (Note 1)	6		mJ
$P_D$	Power Dissipation ( $T_C = 25^\circ\text{C}$ ) - Derate above $25^\circ\text{C}$	60	30	W
		0.48	0.23	W/ $^\circ\text{C}$
$T_J, T_{STG}$	Operating and Storage Temperature Range	-55 to +150		$^\circ\text{C}$
$T_L$	Maximum lead temperature for soldering purposes, 1/8" from case for 5 seconds	300		$^\circ\text{C}$

\* Drain current limited by maximum junction temperature

### Thermal Resistance Characteristics

Symbol	Parameter	TO-220	TO-220F	Unit
$R_{\theta JC}$	Thermal Resistance, Junction-to-Case, Max.	2.1	4.16	$^\circ\text{C}/\text{W}$
$R_{\theta CS}$	Thermal Resistance, Case-to-Sink, Typ.	0.5	--	$^\circ\text{C}/\text{W}$
$R_{\theta JA}$	Thermal Resistance, Junction-to-Ambient, Max.	62.5	62.5	$^\circ\text{C}/\text{W}$

**Electrical Characteristics**  $T_J=25^\circ\text{C}$  unless otherwise specified

Symbol	Parameter	Test Conditions	Min	Typ	Max	Unit
<b>On Characteristics</b>						
$V_{GS}$	Gate Threshold Voltage	$V_{DS} = V_{GS}, I_D = 250 \mu\text{A}$	2.0	--	4.0	V
$R_{DS(ON)}$	Static Drain-Source On-Resistance	$V_{GS} = 10 \text{ V}, I_D = 4.5 \text{ A}$	--	0.34	0.4	m $\Omega$
$g_{FS}$	Forward Transconductance	$V_{DS} = 10 \text{ V}, I_D = 4.5 \text{ A}$	--	5.5	--	S
<b>Off Characteristics</b>						
$BV_{DSS}$	Drain-Source Breakdown Voltage	$V_{GS} = 0 \text{ V}, I_D = 250 \mu\text{A}$	200	--	--	V
$I_{DSS}$	Zero Gate Voltage Drain Current	$V_{DS} = 200 \text{ V}, V_{GS} = 0 \text{ V}$	--	--	1	$\mu\text{A}$
		$V_{DS} = 160 \text{ V}, T_C = 125^\circ\text{C}$	--	--	10	$\mu\text{A}$
$I_{GSS}$	Gate-Body Leakage Current	$V_{GS} = \pm 30 \text{ V}, V_{DS} = 0 \text{ V}$	--	--	$\pm 100$	nA
<b>Dynamic Characteristics</b>						
$C_{iss}$	Input Capacitance	$V_{DS} = 25 \text{ V}, V_{GS} = 0 \text{ V},$ $f = 1.0 \text{ MHz}$	--	420	525	pF
$C_{oss}$	Output Capacitance		--	99	128	pF
$C_{rss}$	Reverse Transfer Capacitance		--	24	28	pF
<b>Switching Characteristics</b>						
$t_{d(on)}$	Turn-On Time	$V_{DS} = 100 \text{ V}, I_D = 9 \text{ A},$ $R_G = 25 \Omega$  (Note 4,5)	--	11	--	ns
$t_r$	Turn-On Rise Time		--	91	--	ns
$t_{d(off)}$	Turn-Off Delay Time		--	70	--	ns
$t_f$	Turn-Off Fall Time		--	72	--	ns
$Q_g$	Total Gate Charge	$V_{DS} = 160 \text{ V}, I_D = 9 \text{ A},$ $V_{GS} = 10 \text{ V}$  (Note 4,5)	--	12	17	nC
$Q_{gs}$	Gate-Source Charge		--	2.4	--	nC
$Q_{gd}$	Gate-Drain Charge		--	3.5	--	nC
<b>Drain-Source Diode Characteristics and Maximum Ratings</b>						
$I_S$	Maximum Continuous Drain-Source Diode Forward Current		--	--	9	A
$I_{SM}$	Maximum Pulsed Drain-Source Diode Forward Current		--	--	36	
$V_{SD}$	Drain-Source Diode Forward Voltage	$V_{GS} = 0 \text{ V}, I_S = 9 \text{ A}$	--	--	1.4	V
$t_{rr}$	Reverse Recovery Time	$V_{GS} = 0 \text{ V}, I_S = 9 \text{ A}$ $di_F/dt = 100 \text{ A}/\mu\text{s}$	--	158	--	ns
$Q_{rr}$	Reverse Recovery Charge		--	0.97	--	$\mu\text{C}$

**Notes :**

1. Repetitive Rating : Pulse width limited by maximum junction temperature
2.  $L=4.3\text{mH}, I_{AS}=9\text{A}, V_{DD}=25\text{V}, R_G=25\Omega,$  Starting  $T_J=25^\circ\text{C}$
3.  $I_{SD}\leq 9\text{A}, di/dt\leq 300\text{A}/\mu\text{s}, V_{DD}\leq BV_{DSS},$  Starting  $T_J=25^\circ\text{C}$
4. Pulse Test : Pulse Width  $\leq 300\mu\text{s},$  Duty Cycle  $\leq 2\%$
5. Essentially Independent of Operating Temperature

Typical Characteristics

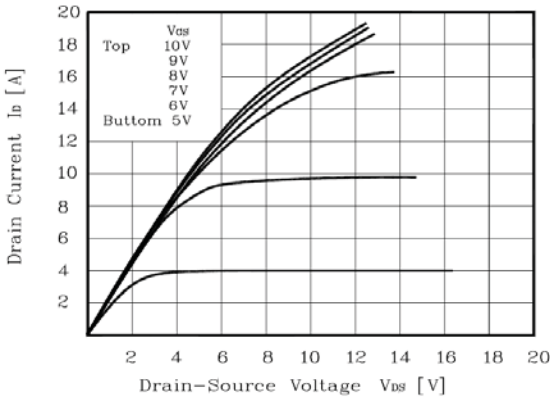

Figure 1. On Region Characteristics

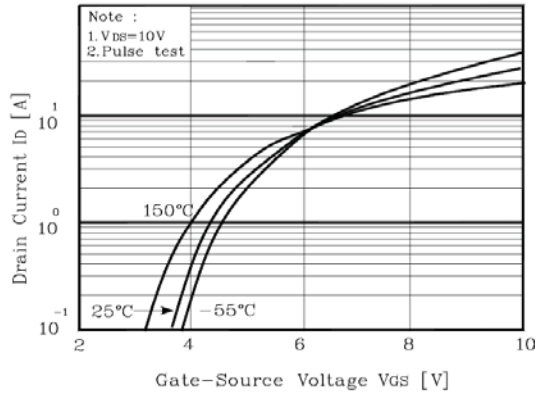

Figure 2. Transfer Characteristics

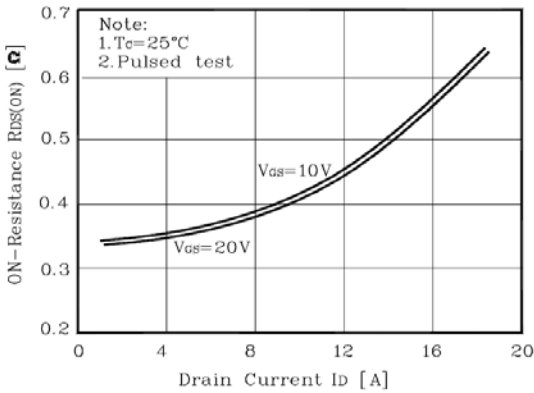

Figure 3. On Resistance Variation vs Drain Current and Gate Voltage

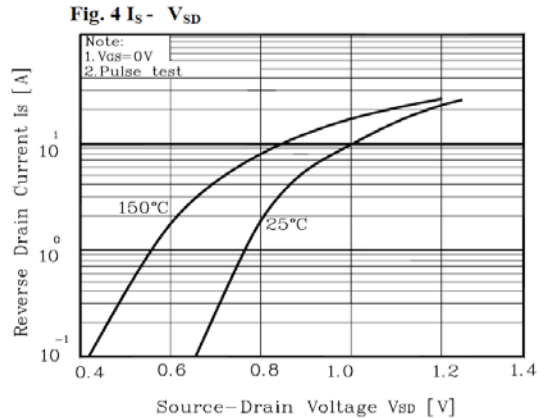

Figure 4. Body Diode Forward Voltage Variation with Source Current and Temperature

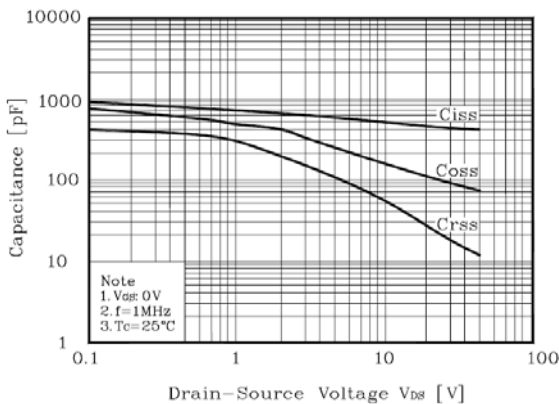

Figure 5. Capacitance Characteristics

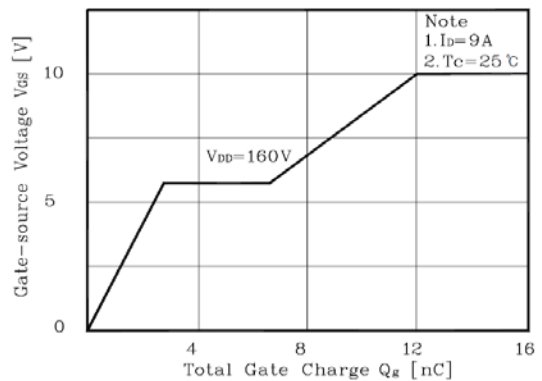

Figure 6. Gate Charge Characteristics

Typical Characteristics (continued)

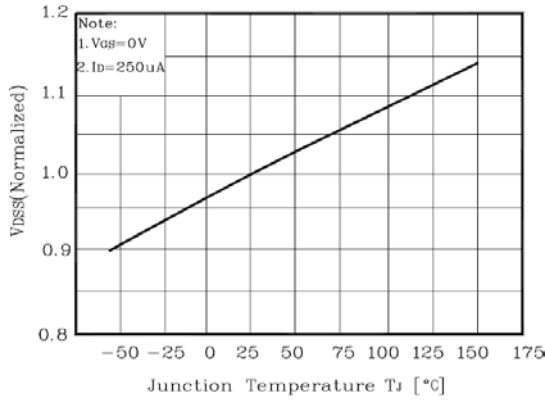

Figure 7. Breakdown Voltage Variation vs Temperature

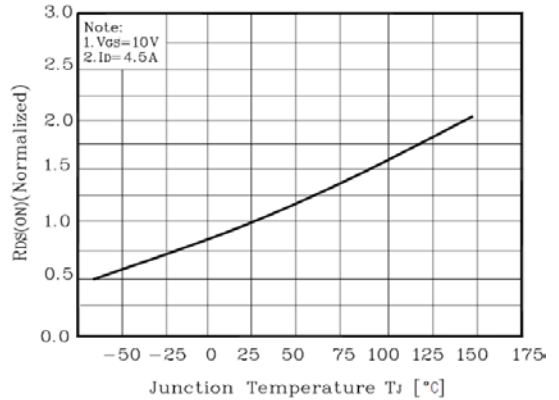

Figure 8. On-Resistance Variation vs Temperature

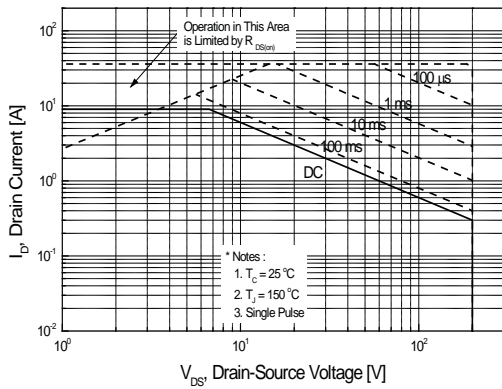

Figure 9-1. Maximum Safe Operating Area for TO-220

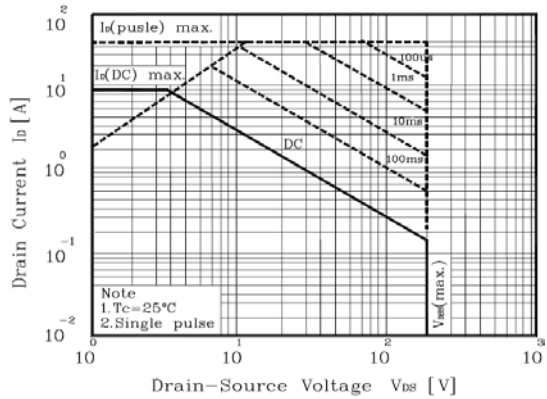

Figure 9-2. Maximum Safe Operating Area for TO-220F

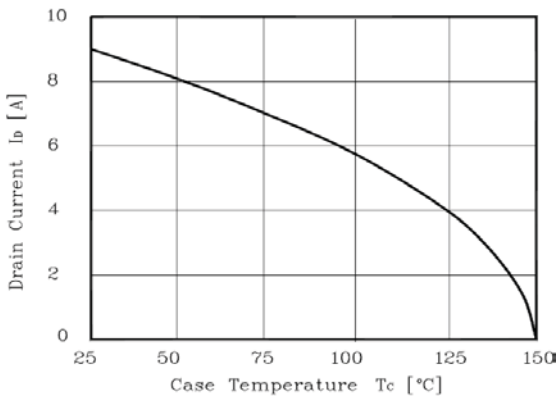

Figure 10. Maximum Drain Current vs Case Temperature

Typical Characteristics (continued)

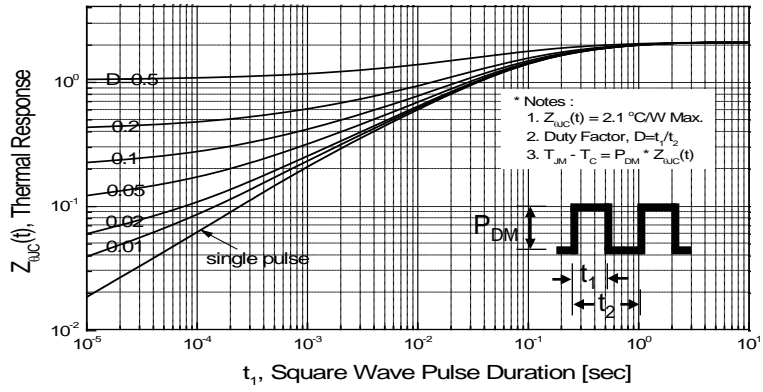

Figure 11-1. Transient Thermal Response Curve for TO-220

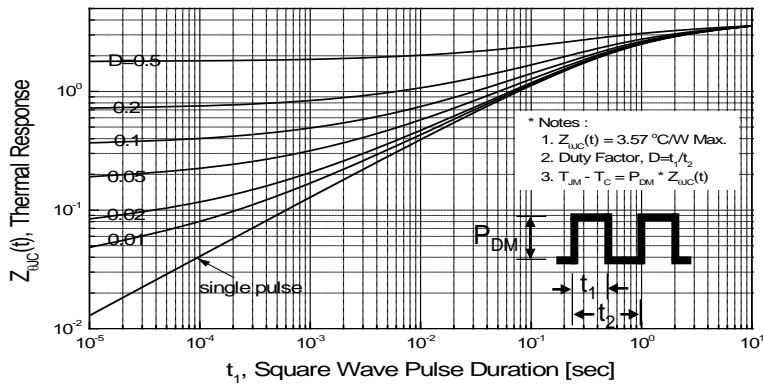

Figure 11-2. Transient Thermal Response Curve for TO-220F

Fig 12. Gate Charge Test Circuit & Waveform

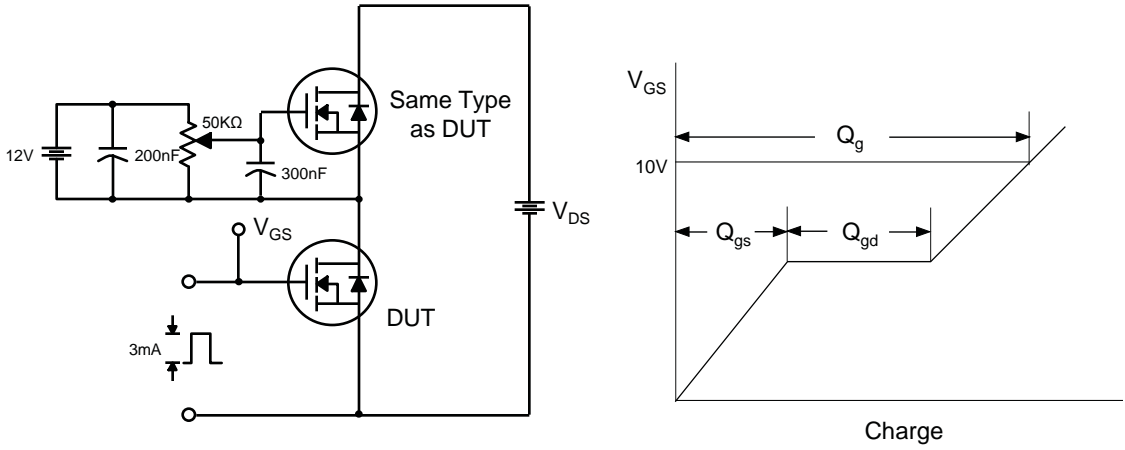

Fig 13. Resistive Switching Test Circuit & Waveforms

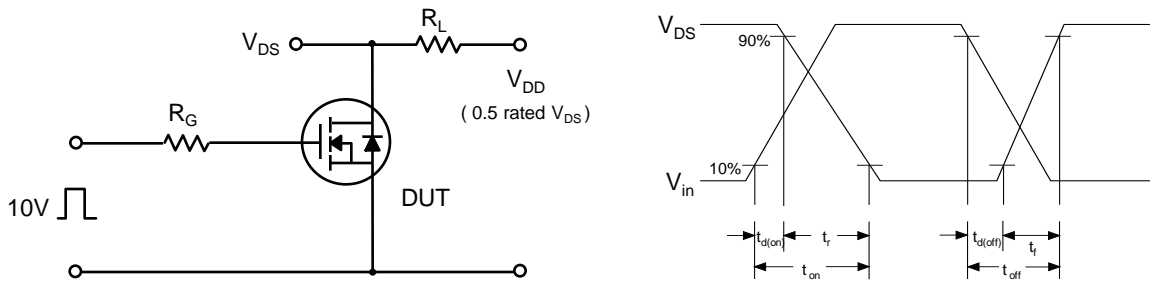

Fig 14. Unclamped Inductive Switching Test Circuit & Waveforms

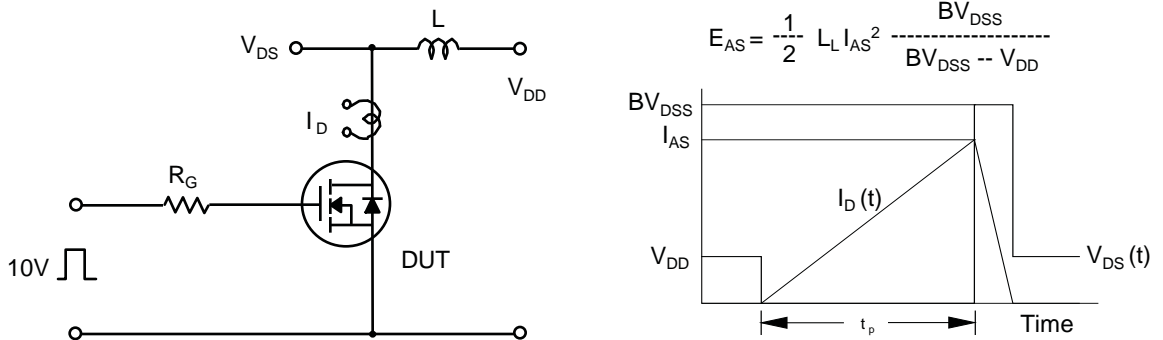
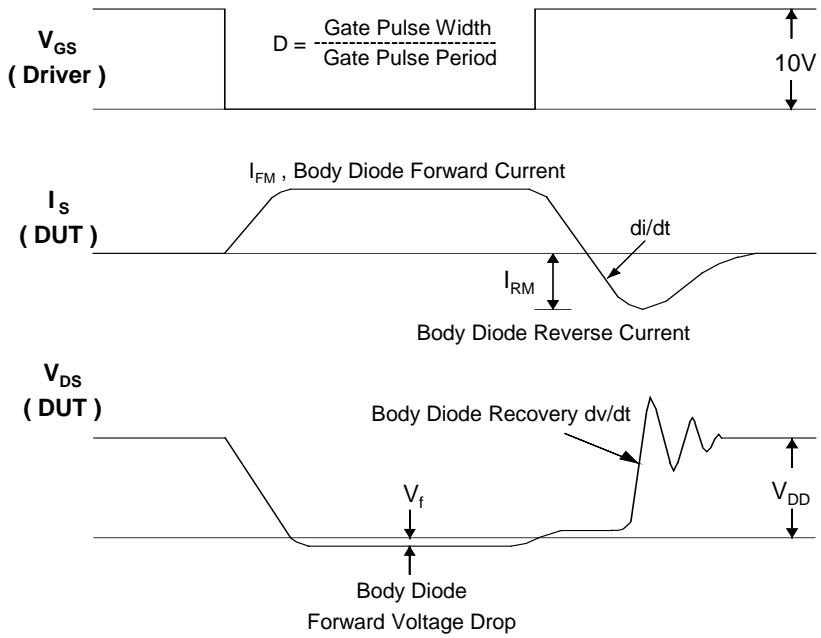
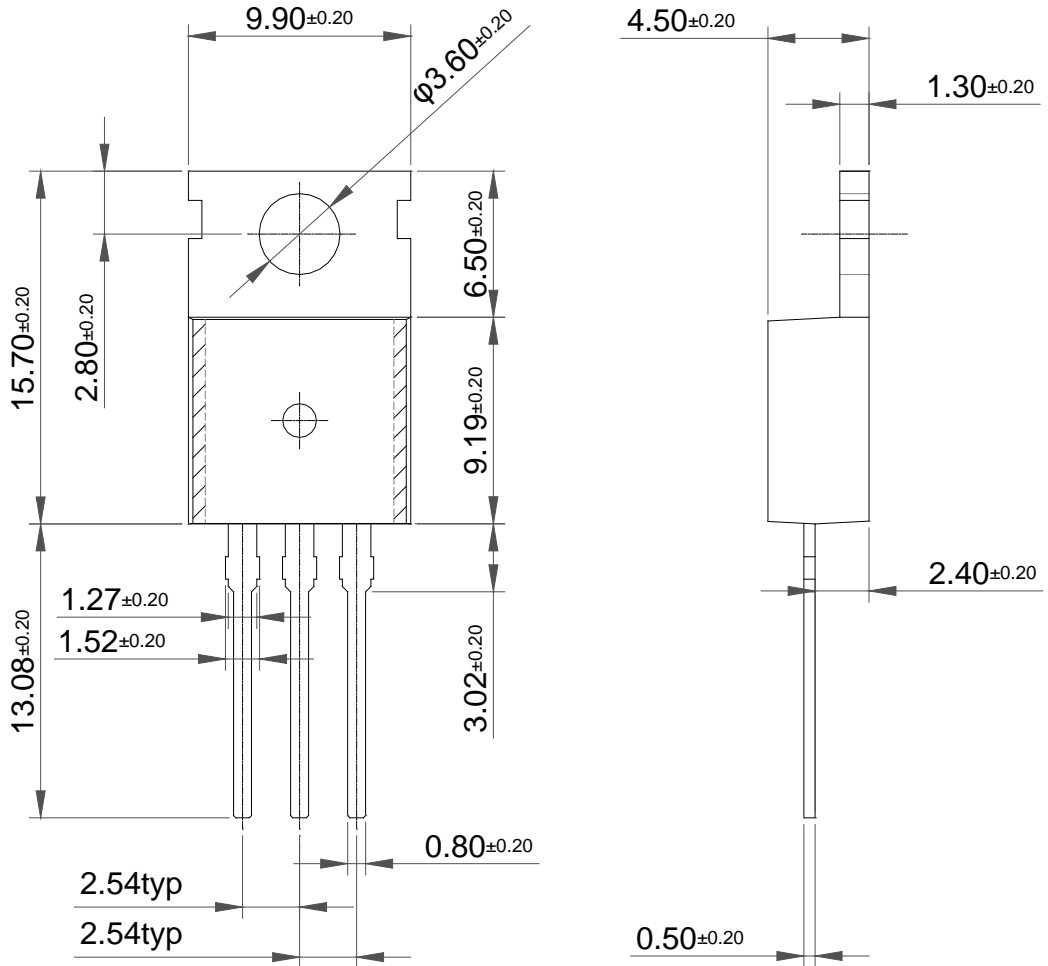

Fig 15. Peak Diode Recovery dv/dt Test Circuit & Waveforms



# Package Dimension

## TO-220



HFP630A\_HFS630A



Package Dimension

TO-220F

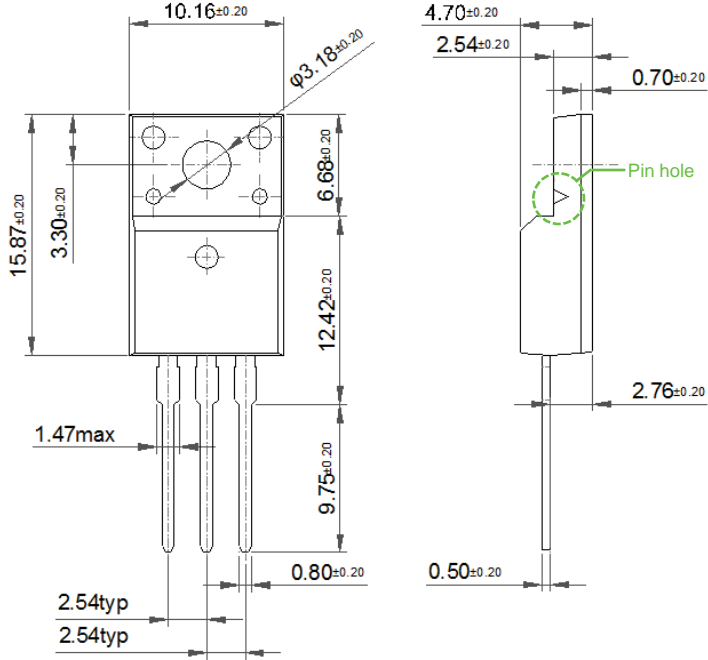

TO-220F-FM

