

HFU5N65F / HFD5N65F

650V N-Channel MOSFET

Features

- Originative New Design
- Very Low Intrinsic Capacitances
- Excellent Switching Characteristics
- 100% Avalanche Tested
- RoHS Compliant

Key Parameters

Parameter	Value	Unit
BV_{DSS}	650	V
I_D	5	A
$R_{DS(on), Typ}$	2	Ω
Qg, Typ	12.5	nC

HFU5N65F
TO-251

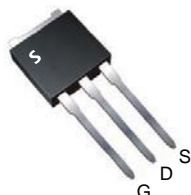

HFD5N65F
TO-252

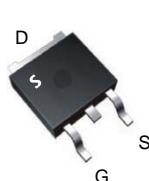

Symbol

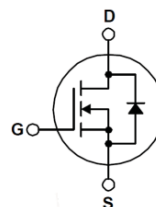

Absolute Maximum Ratings $T_C=25^\circ\text{C}$ unless otherwise specified

Symbol	Parameter	Value	Unit
V_{DSS}	Drain-Source Voltage	650	V
I_D	Drain Current – Continuous ($T_C = 25^\circ\text{C}$)	5.0 *	A
	Drain Current – Continuous ($T_C = 100^\circ\text{C}$)	3.2 *	A
I_{DM}	Drain Current – Pulsed (Note 1)	20 *	A
V_{GS}	Gate-Source Voltage	± 30	V
E_{AS}	Single Pulsed Avalanche Energy (Note 2)	110	mJ
I_{AR}	Avalanche Current (Note 1)	5.0	A
E_{AR}	Repetitive Avalanche Energy (Note 1)	7.8	mJ
dv/dt	Peak Diode Recovery dv/dt (Note 3)	4.5	V/ns
P_D	Power Dissipation ($T_A = 25^\circ\text{C}$)*	2.5	W
	Power Dissipation ($T_C = 25^\circ\text{C}$) - Derate above 25°C	78	W
		0.62	W/ $^\circ\text{C}$
T_J, T_{STG}	Operating and Storage Temperature Range	-55 to +150	$^\circ\text{C}$
T_L	Maximum lead temperature for soldering purposes, 1/8" from case for 5 seconds	300	$^\circ\text{C}$

* Drain current limited by maximum junction temperature

Thermal Resistance Characteristics

Symbol	Parameter	Value	Unit
$R_{\theta JC}$	Junction-to-Case, Max.	1.6	$^\circ\text{C}/\text{W}$
$R_{\theta JA}$	Junction-to-Ambient (minimum pad of 2 oz copper), Max.	110	$^\circ\text{C}/\text{W}$
$R_{\theta JA}$	Junction-to-Ambient (* 1 in ² pad of 2 oz copper), Max.	50	$^\circ\text{C}/\text{W}$

Electrical Characteristics $T_J=25^\circ\text{C}$ unless otherwise specified

Symbol	Parameter	Test Conditions	Min	Typ	Max	Unit
On Characteristics						
V_{GS}	Gate Threshold Voltage	$V_{DS} = V_{GS}, I_D = 250 \mu\text{A}$	2.0	--	4.0	V
$R_{DS(ON)}$	Static Drain-Source On-Resistance	$V_{GS} = 10 \text{ V}, I_D = 2.5 \text{ A}$	--	2.0	2.5	Ω
g_{FS}	Forward Transconductance	$V_{DS} = 30 \text{ V}, I_D = 2.5 \text{ A}$	--	3	--	S
Off Characteristics						
BV_{DSS}	Drain-Source Breakdown Voltage	$V_{GS} = 0 \text{ V}, I_D = 250 \mu\text{A}$	650	--	--	V
I_{DSS}	Zero Gate Voltage Drain Current	$V_{DS} = 650 \text{ V}, V_{GS} = 0 \text{ V}$	--	--	10	μA
		$V_{DS} = 520 \text{ V}, T_C = 125^\circ\text{C}$	--	--	100	μA
I_{GSS}	Gate-Body Leakage Current	$V_{GS} = \pm 30 \text{ V}, V_{DS} = 0 \text{ V}$	--	--	± 100	nA
Dynamic Characteristics						
C_{iss}	Input Capacitance	$V_{DS} = 25 \text{ V}, V_{GS} = 0 \text{ V},$ $f = 1.0 \text{ MHz}$	--	560	730	pF
C_{oss}	Output Capacitance		--	70	90	pF
C_{rss}	Reverse Transfer Capacitance		--	14	18.5	pF
Switching Characteristics						
$t_{d(on)}$	Turn-On Time	$V_{DS} = 325 \text{ V}, I_D = 5 \text{ A},$ $R_G = 25 \Omega$ (Note 4,5)	--	19	48	ns
t_r	Turn-On Rise Time		--	19	48	ns
$t_{d(off)}$	Turn-Off Delay Time		--	35	80	ns
t_f	Turn-Off Fall Time		--	22	54	ns
Q_g	Total Gate Charge	$V_{DS} = 520 \text{ V}, I_D = 5 \text{ A},$ $V_{GS} = 10 \text{ V}$ (Note 4,5)	--	12.5	16.5	nC
Q_{gs}	Gate-Source Charge		--	2.8	--	nC
Q_{gd}	Gate-Drain Charge		--	4.0	--	nC
Drain-Source Diode Characteristics and Maximum Ratings						
I_S	Maximum Continuous Drain-Source Diode Forward Current		--	--	5	A
I_{SM}	Maximum Pulsed Drain-Source Diode Forward Current		--	--	20	
V_{SD}	Drain-Source Diode Forward Voltage	$V_{GS} = 0 \text{ V}, I_S = 5 \text{ A}$	--	--	1.4	V
t_{rr}	Reverse Recovery Time	$V_{GS} = 0 \text{ V}, I_S = 5 \text{ A}$ $di_F/dt = 100 \text{ A}/\mu\text{s}$	--	250	--	ns
Q_{rr}	Reverse Recovery Charge		--	1.6	--	μC

Notes :

1. Repetitive Rating : Pulse width limited by maximum junction temperature
2. $L=8\text{mH}, I_{AS}=5\text{A}, V_{DD}=50\text{V}, R_G=25\Omega,$ Starting $T_J=25^\circ\text{C}$
3. $I_{SD}\leq 5\text{A}, di/dt\leq 200\text{A}/\mu\text{s}, V_{DD}\leq BV_{DSS},$ Starting $T_J=25^\circ\text{C}$
4. Pulse Test : Pulse Width $\leq 300\mu\text{s},$ Duty Cycle $\leq 2\%$
5. Essentially Independent of Operating Temperature

Typical Characteristics

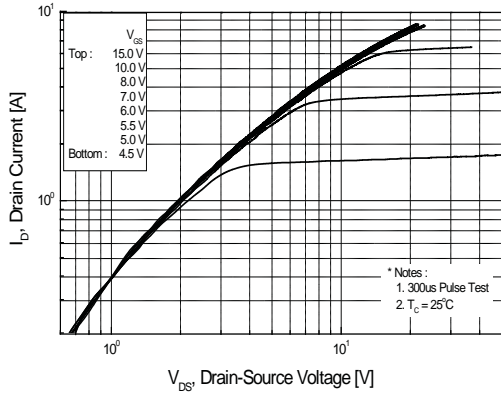

Figure 1. On Region Characteristics

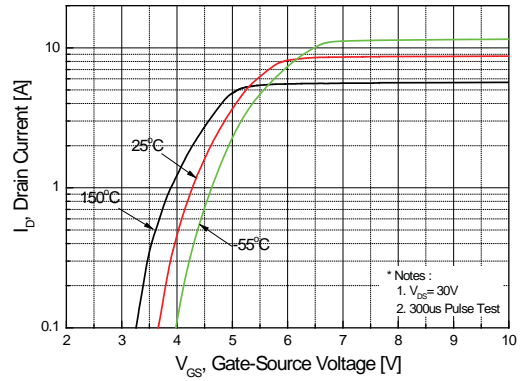

Figure 2. Transfer Characteristics

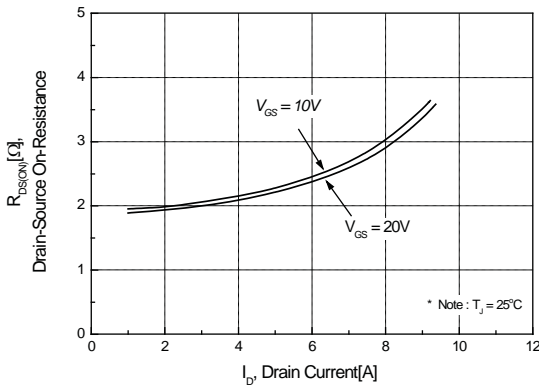

Figure 3. On Resistance Variation vs Drain Current and Gate Voltage

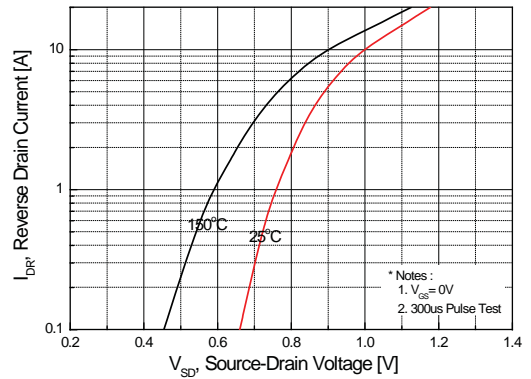

Figure 4. Body Diode Forward Voltage Variation with Source Current and Temperature

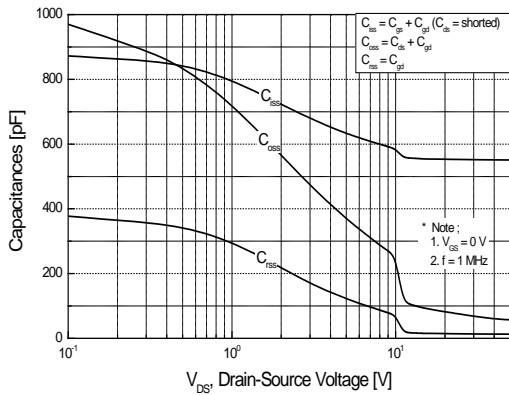

Figure 5. Capacitance Characteristics

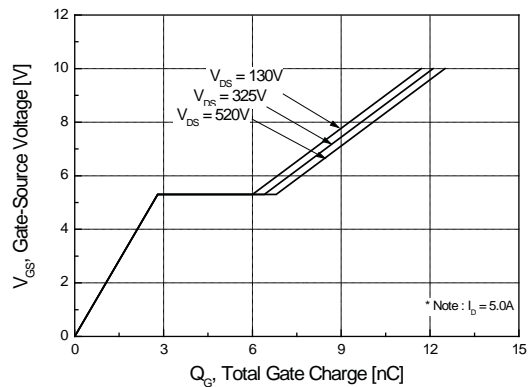

Figure 6. Gate Charge Characteristics

Typical Characteristics (continued)

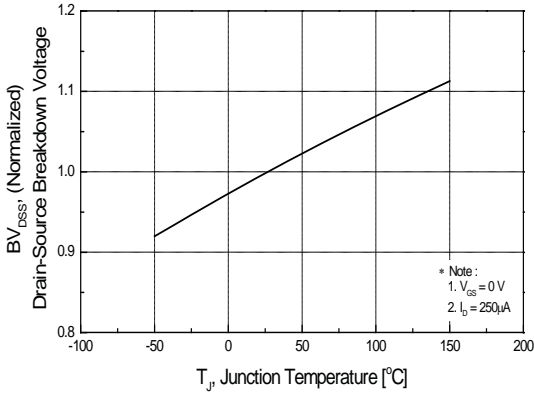

Figure 7. Breakdown Voltage Variation vs Temperature

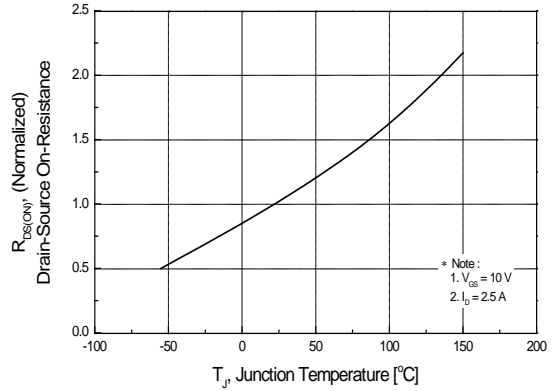

Figure 8. On-Resistance Variation vs Temperature

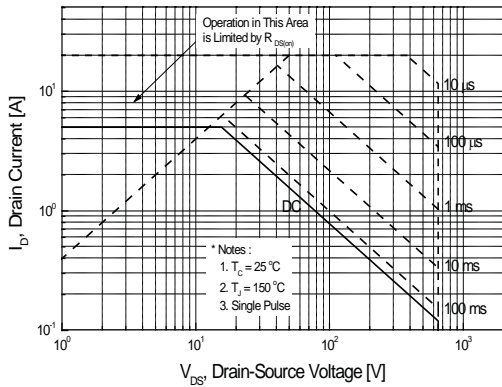

Figure 9. Maximum Safe Operating Area

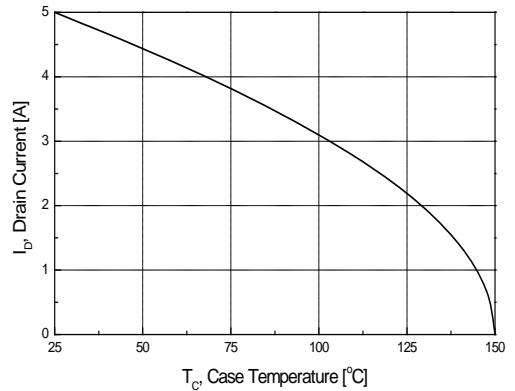

Figure 10. Maximum Drain Current vs Case Temperature

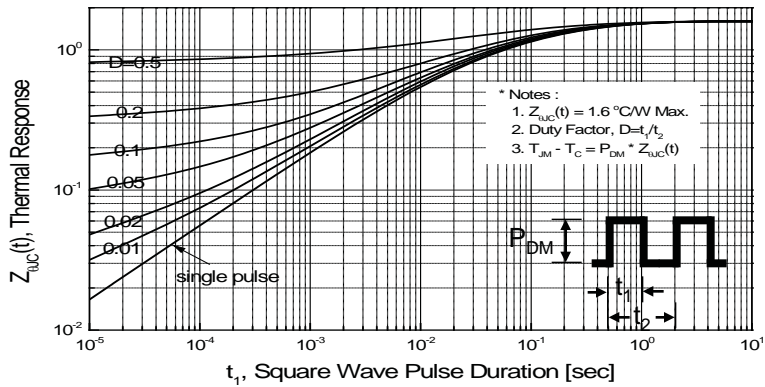

Figure 11. Transient Thermal Response Curve

Fig 12. Gate Charge Test Circuit & Waveform



Fig 13. Resistive Switching Test Circuit & Waveforms

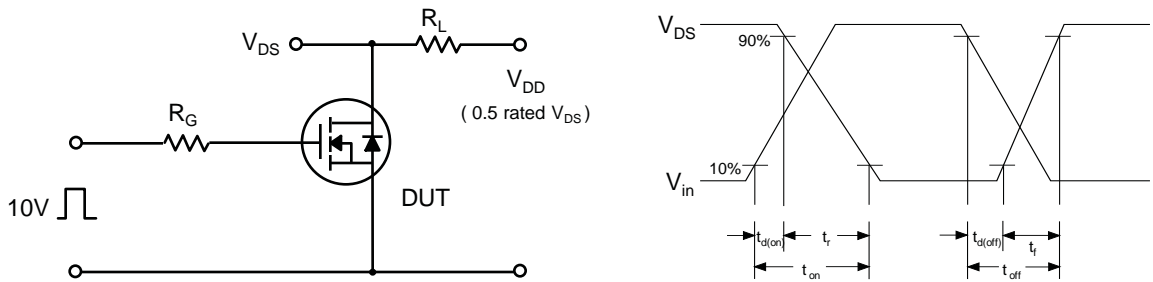

Fig 14. Unclamped Inductive Switching Test Circuit & Waveforms

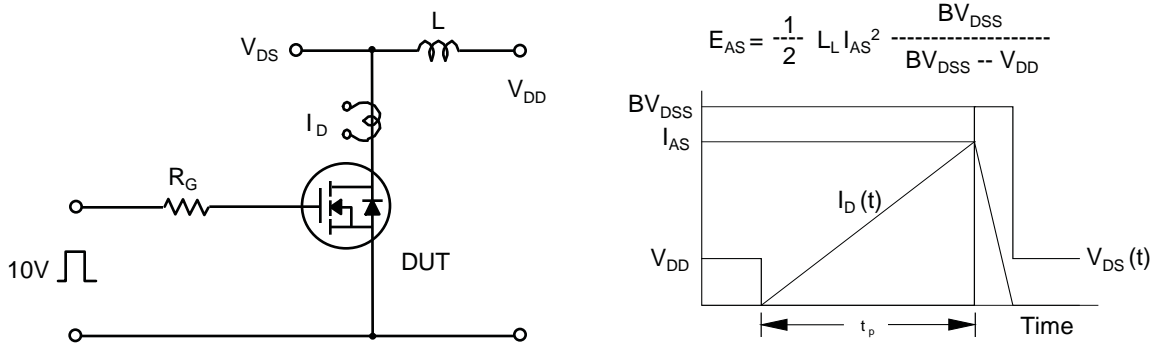
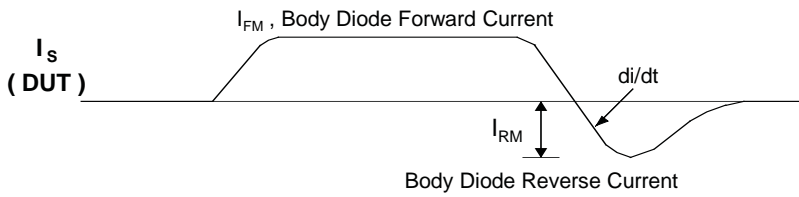
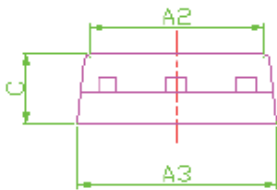
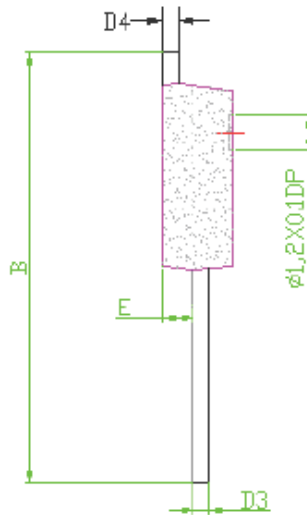
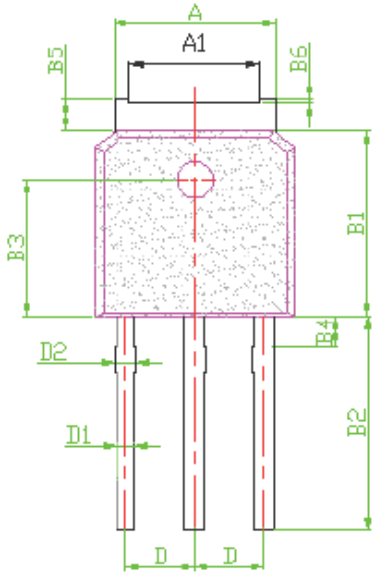

Fig 15. Peak Diode Recovery dv/dt Test Circuit & Waveforms



Package Dimension

I-PAK
(TO-251L)



DIM	MILLIMETERS
A	5.33 ± 0.2
A1	4.33 ± 0.2
A2	5.78 ± 0.1
A3	6.6 ± 0.2
B	14.15 ± 0.5
B1	6.1 ± 0.3
B2	7.0 ± 0.5
B3	4.5 ± 0.25
B4	1.0 ± 0.1
B5	1.05 ± 0.1
B6	0.1 ± 0.05
C	2.3 ± 0.2
D	2.286 ± 0.05
D1	0.62 ± 0.15
D2	0.75 ± 0.15
D3	0.5 ± 0.15
D4	0.5 ± 0.15
E	1.01 ± 0.2
DIA	$\odot 1.2(\text{deep } 0.1)$

Unit : mm

Package Dimension

I-PAK
(TO-251L 2.5mm Short Lead)

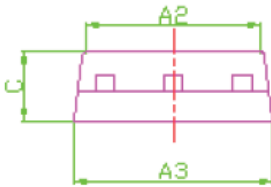
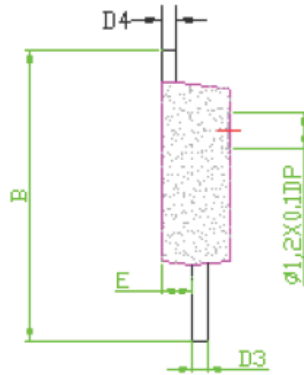
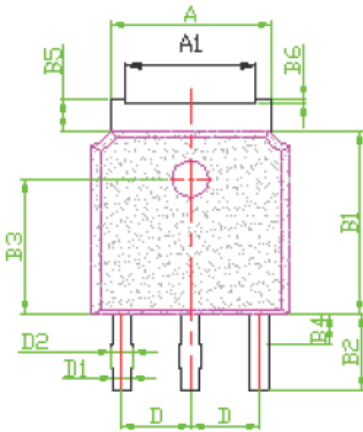

DIM	MILLIMETERS
A	5.33 ± 0.2
A1	4.33 ± 0.2
A2	5.78 ± 0.1
A3	6.6 ± 0.2
B	9.65 ± 0.5
B1	6.1 ± 0.3
B2	2.5 ± 0.5
B3	4.5 ± 0.25
B4	1.0 ± 0.1
B5	1.05 ± 0.1
B6	0.1 ± 0.05
C	2.3 ± 0.2
D	2.286 ± 0.05
D1	0.62 ± 0.15
D2	0.75 ± 0.15
D3	0.5 ± 0.15
D4	0.5 ± 0.15
E	1.01 ± 0.2
DIA	$\odot 1.2 (\text{deep } 0.1)$

Unit :mm

Package Dimension

D-PAK
(TO-252L)

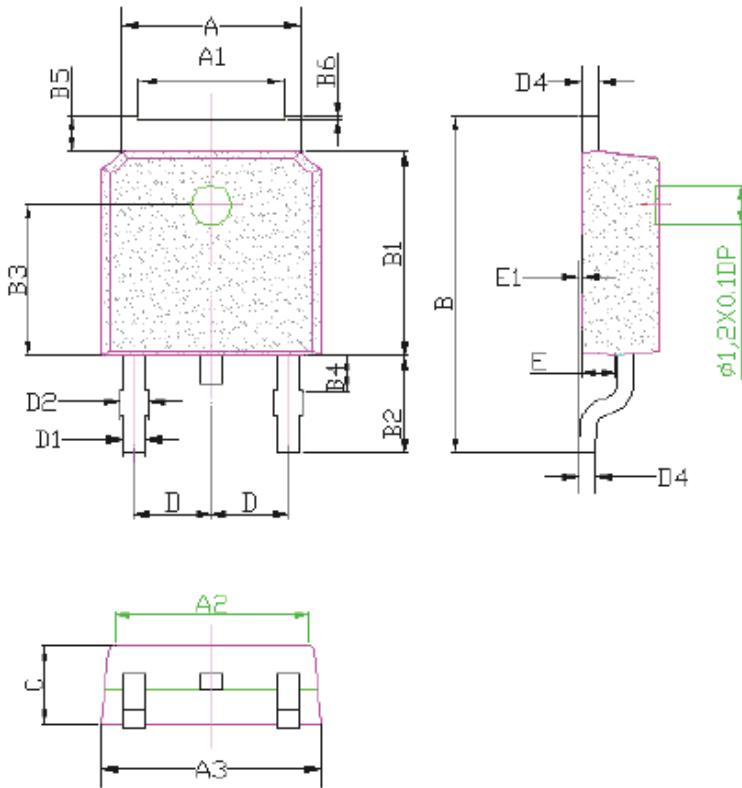

DIM	MILLIMETERS
A	5.33 ± 0.2
A1	4.33 ± 0.2
A2	5.78 ± 0.1
A3	6.6 ± 0.2
B	10 ± 0.5
B1	6.1 ± 0.3
B2	2.85 ± 0.5
B3	4.5 ± 0.25
B4	1.0 ± 0.1
B5	1.05 ± 0.1
B6	0.1 ± 0.05
C	2.3 ± 0.2
D	2.286 ± 0.05
D1	0.62 ± 0.15
D2	0.75 ± 0.15
D3	0.5 ± 0.15
D4	0.5 ± 0.15
E	1.01 ± 0.2
E1	0.1 ± 0.05
DIA	$\odot 1.2$ (deep 0.1)

Unit :mm