

# HFS4N65FS

## 650V N-Channel MOSFET

### Features

- Originative New Design
- Very Low Intrinsic Capacitances
- Excellent Switching Characteristics
- 100% Avalanche Tested
- Single Gauge Package

### Key Parameters

Parameter	Value	Unit
$BV_{DSS}$	650	V
$I_D$	4	A
$R_{DS(on), Typ}$	3	$\Omega$
$Qg, Typ$	8.5	nC

TO-220FS

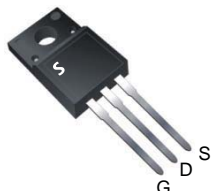

Symbol

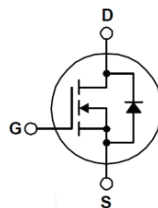

### Absolute Maximum Ratings $T_C=25^\circ\text{C}$ unless otherwise specified

Symbol	Parameter	Value	Unit
$V_{DSS}$	Drain-Source Voltage	650	V
$I_D$	Drain Current – Continuous ( $T_C = 25^\circ\text{C}$ )	4.0 *	A
	Drain Current – Continuous ( $T_C = 100^\circ\text{C}$ )	2.5 *	A
$I_{DM}$	Drain Current – Pulsed (Note 1)	16 *	A
$V_{GS}$	Gate-Source Voltage	$\pm 30$	V
$E_{AS}$	Single Pulsed Avalanche Energy (Note 2)	70	mJ
$I_{AR}$	Avalanche Current (Note 1)	4.0	A
$E_{AR}$	Repetitive Avalanche Energy (Note 1)	11	mJ
dv/dt	Peak Diode Recovery dv/dt (Note 3)	4.5	V/ns
$P_D$	Power Dissipation ( $T_C = 25^\circ\text{C}$ )	35	W
	- Derate above $25^\circ\text{C}$	0.28	W/ $^\circ\text{C}$
$T_J, T_{STG}$	Operating and Storage Temperature Range	-55 to +150	$^\circ\text{C}$
$T_L$	Maximum lead temperature for soldering purposes, 1/8" from case for 5 seconds	300	$^\circ\text{C}$

\* Drain current limited by maximum junction temperature

### Thermal Resistance Characteristics

Symbol	Parameter	Value	Unit
$R_{\theta JC}$	Thermal Resistance, Junction-to-Case, Max.	3.6	$^\circ\text{C}/\text{W}$
$R_{\theta JA}$	Thermal Resistance, Junction-to-Ambient, Max.	62.5	$^\circ\text{C}/\text{W}$

**Electrical Characteristics**  $T_J=25^\circ\text{C}$  unless otherwise specified

Symbol	Parameter	Test Conditions	Min	Typ	Max	Unit
<b>On Characteristics</b>						
$V_{GS}$	Gate Threshold Voltage	$V_{DS} = V_{GS}, I_D = 250 \mu\text{A}$	2.0	--	4.0	V
$R_{DS(ON)}$	Static Drain-Source On-Resistance	$V_{GS} = 10 \text{ V}, I_D = 2 \text{ A}$	--	3.0	3.8	$\Omega$
$g_{FS}$	Forward Transconductance	$V_{DS} = 30 \text{ V}, I_D = 2 \text{ A}$	--	2.2	--	S
<b>Off Characteristics</b>						
$BV_{DSS}$	Drain-Source Breakdown Voltage	$V_{GS} = 0 \text{ V}, I_D = 250 \mu\text{A}$	650	--	--	V
$I_{DSS}$	Zero Gate Voltage Drain Current	$V_{DS} = 650 \text{ V}, V_{GS} = 0 \text{ V}$	--	--	10	$\mu\text{A}$
		$V_{DS} = 520 \text{ V}, T_C = 125^\circ\text{C}$	--	--	100	$\mu\text{A}$
$I_{GSS}$	Gate-Body Leakage Current	$V_{GS} = \pm 30 \text{ V}, V_{DS} = 0 \text{ V}$	--	--	$\pm 100$	nA
<b>Dynamic Characteristics</b>						
$C_{iss}$	Input Capacitance	$V_{DS} = 25 \text{ V}, V_{GS} = 0 \text{ V},$ $f = 1.0 \text{ MHz}$	--	380	500	pF
$C_{oss}$	Output Capacitance		--	45	60	pF
$C_{rss}$	Reverse Transfer Capacitance		--	6.5	8.5	pF
<b>Switching Characteristics</b>						
$t_{d(on)}$	Turn-On Time	$V_{DS} = 325 \text{ V}, I_D = 4 \text{ A},$ $R_G = 25 \Omega$  (Note 4,5)	--	19	48	ns
$t_r$	Turn-On Rise Time		--	19	48	ns
$t_{d(off)}$	Turn-Off Delay Time		--	35	80	ns
$t_f$	Turn-Off Fall Time		--	22	54	ns
$Q_g$	Total Gate Charge	$V_{DS} = 520 \text{ V}, I_D = 4 \text{ A},$ $V_{GS} = 10 \text{ V}$  (Note 4,5)	--	8.5	11	nC
$Q_{gs}$	Gate-Source Charge		--	2.1	--	nC
$Q_{gd}$	Gate-Drain Charge		--	2.8	--	nC
<b>Drain-Source Diode Characteristics and Maximum Ratings</b>						
$I_S$	Maximum Continuous Drain-Source Diode Forward Current		--	--	4	A
$I_{SM}$	Maximum Pulsed Drain-Source Diode Forward Current		--	--	16	
$V_{SD}$	Drain-Source Diode Forward Voltage	$V_{GS} = 0 \text{ V}, I_S = 4 \text{ A}$	--	--	1.4	V
$t_{rr}$	Reverse Recovery Time	$V_{GS} = 0 \text{ V}, I_S = 4 \text{ A}$ $di_F/dt = 100 \text{ A}/\mu\text{s}$	--	240	--	ns
$Q_{rr}$	Reverse Recovery Charge		--	1.4	--	$\mu\text{C}$

**Notes :**

1. Repetitive Rating : Pulse width limited by maximum junction temperature
2.  $L=8\text{mH}, I_{AS}=4\text{A}, V_{DD}=50\text{V}, R_G=25\Omega,$  Starting  $T_J=25^\circ\text{C}$
3.  $I_{SD}\leq 4\text{A}, di/dt\leq 200\text{A}/\mu\text{s}, V_{DD}\leq BV_{DSS},$  Starting  $T_J=25^\circ\text{C}$
4. Pulse Test : Pulse Width  $\leq 300\mu\text{s},$  Duty Cycle  $\leq 2\%$
5. Essentially Independent of Operating Temperature

# Typical Characteristics

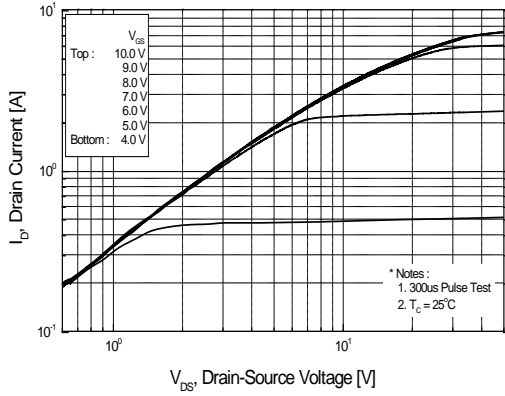

Figure 1. On Region Characteristics

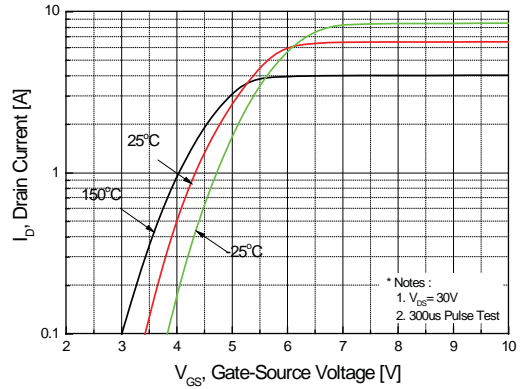

Figure 2. Transfer Characteristics

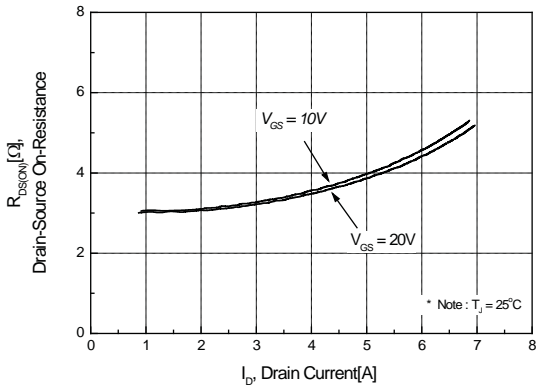

Figure 3. On Resistance Variation vs Drain Current and Gate Voltage

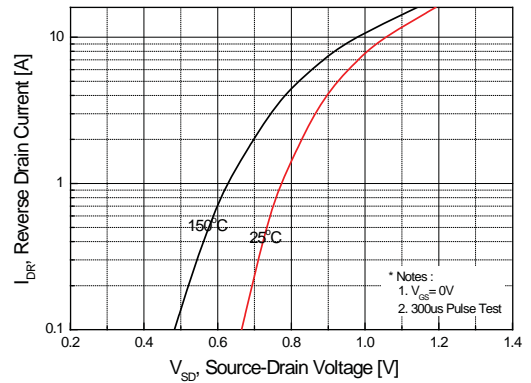

Figure 4. Body Diode Forward Voltage Variation with Source Current and Temperature

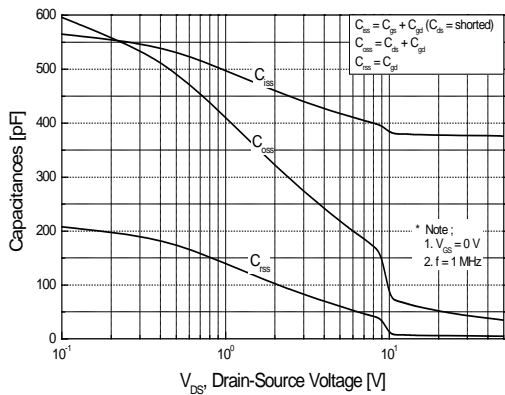

Figure 5. Capacitance Characteristics

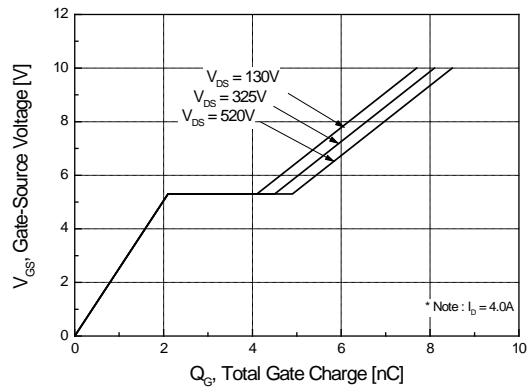

Figure 6. Gate Charge Characteristics

Typical Characteristics (continued)

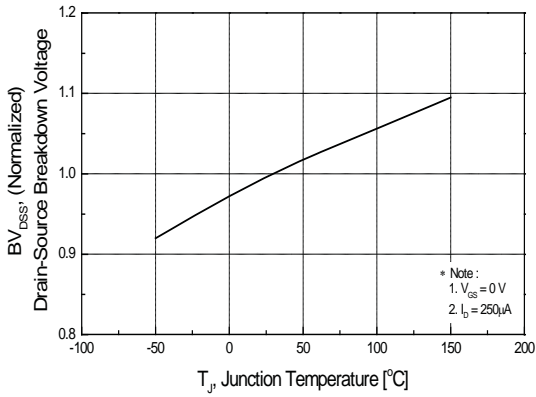

Figure 7. Breakdown Voltage Variation vs Temperature

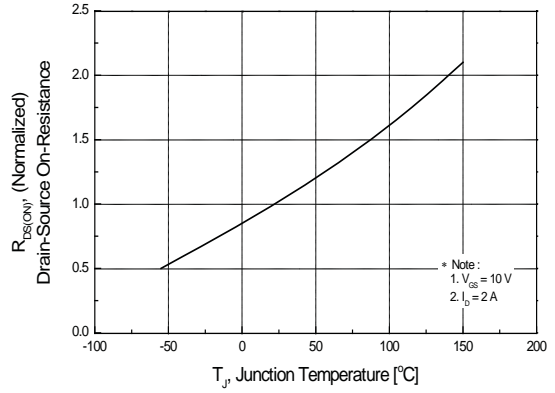

Figure 8. On-Resistance Variation vs Temperature

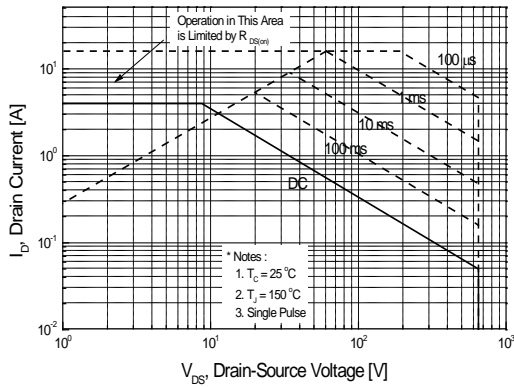

Figure 9. Maximum Safe Operating Area

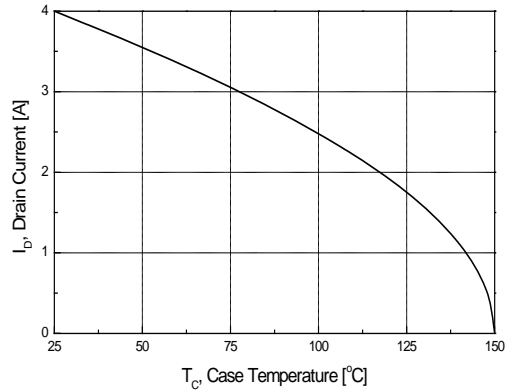

Figure 10. Maximum Drain Current vs Case Temperature

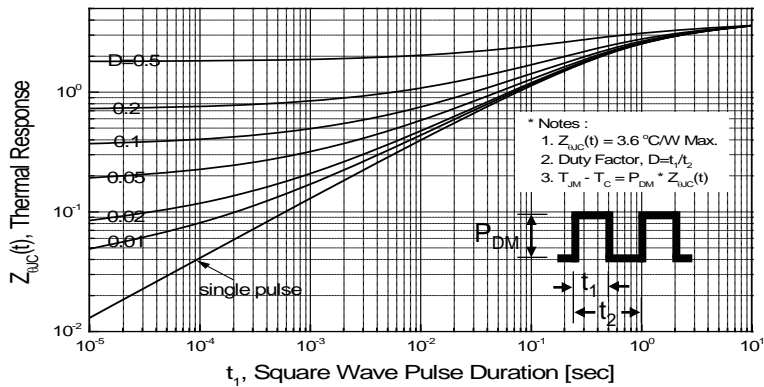

Figure 11. Transient Thermal Response Curve

Fig 12. Gate Charge Test Circuit & Waveform



Fig 13. Resistive Switching Test Circuit & Waveforms

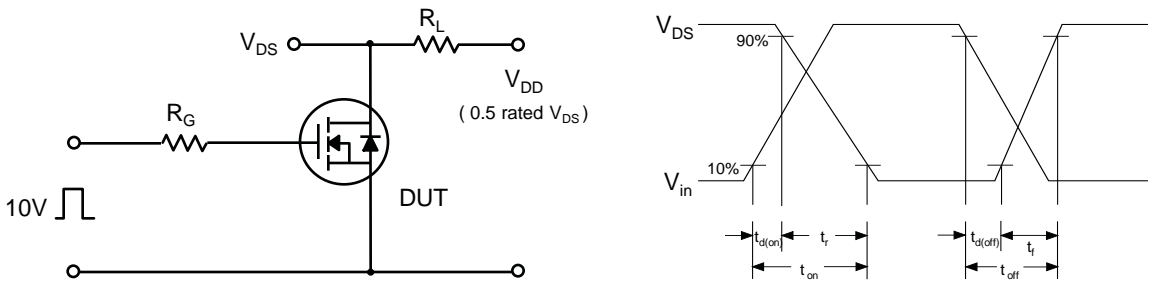

Fig 14. Unclamped Inductive Switching Test Circuit & Waveforms

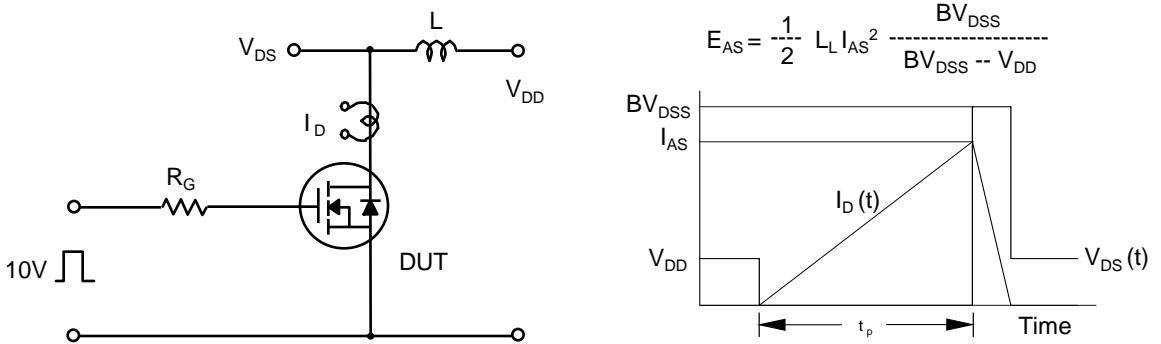
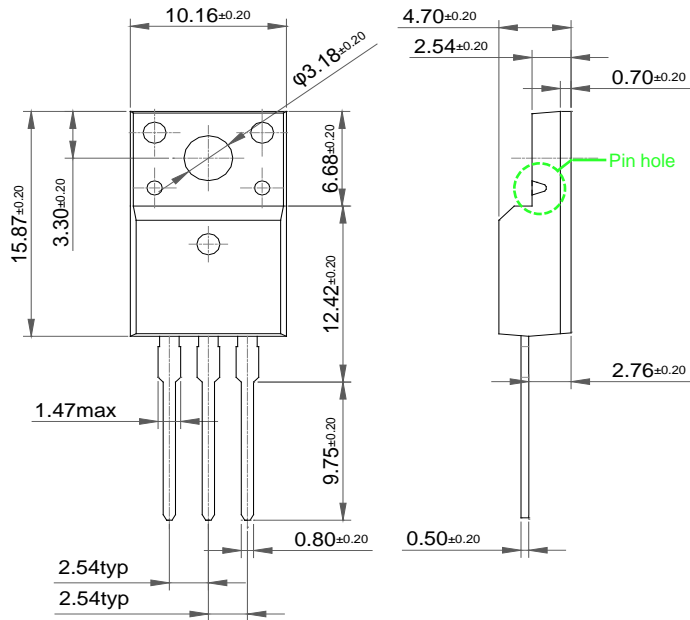

Fig 15. Peak Diode Recovery dv/dt Test Circuit & Waveforms



Package Dimension

TO-220FS



TO-220FS-FM(Full Mold)

