

HFS4N60FS

600V N-Channel MOSFET

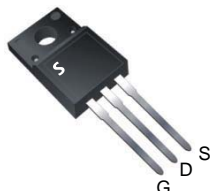
Features

- Originative New Design
- Very Low Intrinsic Capacitances
- Excellent Switching Characteristics
- 100% Avalanche Tested
- Single Gauge Package

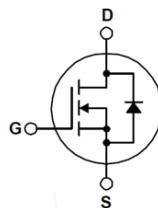
Key Parameters

Parameter	Value	Unit
BV_{DSS}	600	V
I_D	4	A
$R_{DS(on), Typ}$	2.6	Ω
Qg, Typ	8.5	nC

TO-220FS



Symbol



Absolute Maximum Ratings $T_C=25^\circ\text{C}$ unless otherwise specified

Symbol	Parameter	Value	Unit
V_{DSS}	Drain-Source Voltage	600	V
I_D	Drain Current – Continuous ($T_C = 25^\circ\text{C}$)	4.0 *	A
	Drain Current – Continuous ($T_C = 100^\circ\text{C}$)	2.5 *	A
I_{DM}	Drain Current – Pulsed (Note 1)	16 *	A
V_{GS}	Gate-Source Voltage	± 30	V
E_{AS}	Single Pulsed Avalanche Energy (Note 2)	70	mJ
I_{AR}	Avalanche Current (Note 1)	4.0	A
E_{AR}	Repetitive Avalanche Energy (Note 1)	11	mJ
dv/dt	Peak Diode Recovery dv/dt (Note 3)	4.5	V/ns
P_D	Power Dissipation ($T_C = 25^\circ\text{C}$)	35	W
	- Derate above 25°C	0.28	W/ $^\circ\text{C}$
T_J, T_{STG}	Operating and Storage Temperature Range	-55 to +150	$^\circ\text{C}$
T_L	Maximum lead temperature for soldering purposes, 1/8" from case for 5 seconds	300	$^\circ\text{C}$

* Drain current limited by maximum junction temperature

Thermal Resistance Characteristics

Symbol	Parameter	Value	Unit
$R_{\theta JC}$	Thermal Resistance, Junction-to-Case, Max.	3.6	$^\circ\text{C}/\text{W}$
$R_{\theta JA}$	Thermal Resistance, Junction-to-Ambient, Max.	62.5	$^\circ\text{C}/\text{W}$

Electrical Characteristics $T_J=25^\circ\text{C}$ unless otherwise specified

Symbol	Parameter	Test Conditions	Min	Typ	Max	Unit
On Characteristics						
V_{GS}	Gate Threshold Voltage	$V_{DS} = V_{GS}, I_D = 250 \mu\text{A}$	2.0	--	4.0	V
$R_{DS(ON)}$	Static Drain-Source On-Resistance	$V_{GS} = 10 \text{ V}, I_D = 2 \text{ A}$	--	2.6	3.2	Ω
g_{FS}	Forward Transconductance	$V_{DS} = 30 \text{ V}, I_D = 2 \text{ A}$	--	2.2	--	S
Off Characteristics						
BV_{DSS}	Drain-Source Breakdown Voltage	$V_{GS} = 0 \text{ V}, I_D = 250 \mu\text{A}$	600	--	--	V
I_{DSS}	Zero Gate Voltage Drain Current	$V_{DS} = 600 \text{ V}, V_{GS} = 0 \text{ V}$	--	--	10	μA
		$V_{DS} = 480 \text{ V}, T_C = 125^\circ\text{C}$	--	--	100	μA
I_{GSS}	Gate-Body Leakage Current	$V_{GS} = \pm 30 \text{ V}, V_{DS} = 0 \text{ V}$	--	--	± 100	nA
Dynamic Characteristics						
C_{iss}	Input Capacitance	$V_{DS} = 25 \text{ V}, V_{GS} = 0 \text{ V},$ $f = 1.0 \text{ MHz}$	--	380	500	pF
C_{oss}	Output Capacitance		--	45	60	pF
C_{rss}	Reverse Transfer Capacitance		--	6.5	8.5	pF
Switching Characteristics						
$t_{d(on)}$	Turn-On Time	$V_{DS} = 300 \text{ V}, I_D = 4 \text{ A},$ $R_G = 25 \Omega$ (Note 4,5)	--	19	48	ns
t_r	Turn-On Rise Time		--	19	48	ns
$t_{d(off)}$	Turn-Off Delay Time		--	35	80	ns
t_f	Turn-Off Fall Time		--	22	54	ns
Q_g	Total Gate Charge	$V_{DS} = 480 \text{ V}, I_D = 4 \text{ A},$ $V_{GS} = 10 \text{ V}$ (Note 4,5)	--	8.5	11	nC
Q_{gs}	Gate-Source Charge		--	2.1	--	nC
Q_{gd}	Gate-Drain Charge		--	2.8	--	nC
Drain-Source Diode Characteristics and Maximum Ratings						
I_S	Maximum Continuous Drain-Source Diode Forward Current		--	--	4	A
I_{SM}	Maximum Pulsed Drain-Source Diode Forward Current		--	--	16	
V_{SD}	Drain-Source Diode Forward Voltage	$V_{GS} = 0 \text{ V}, I_S = 4 \text{ A}$	--	--	1.4	V
t_{rr}	Reverse Recovery Time	$V_{GS} = 0 \text{ V}, I_S = 4 \text{ A}$ $di_F/dt = 100 \text{ A}/\mu\text{s}$	--	240	--	ns
Q_{rr}	Reverse Recovery Charge		--	1.4	--	μC

Notes :

1. Repetitive Rating : Pulse width limited by maximum junction temperature
2. $L=8\text{mH}, I_{AS}=4\text{A}, V_{DD}=50\text{V}, R_G=25\Omega,$ Starting $T_J=25^\circ\text{C}$
3. $I_{SD}\leq 4\text{A}, di/dt\leq 200\text{A}/\mu\text{s}, V_{DD}\leq BV_{DSS},$ Starting $T_J=25^\circ\text{C}$
4. Pulse Test : Pulse Width $\leq 300\mu\text{s},$ Duty Cycle $\leq 2\%$
5. Essentially Independent of Operating Temperature

Typical Characteristics

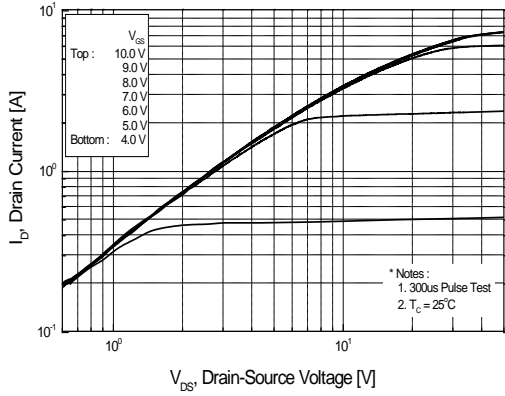


Figure 1. On Region Characteristics

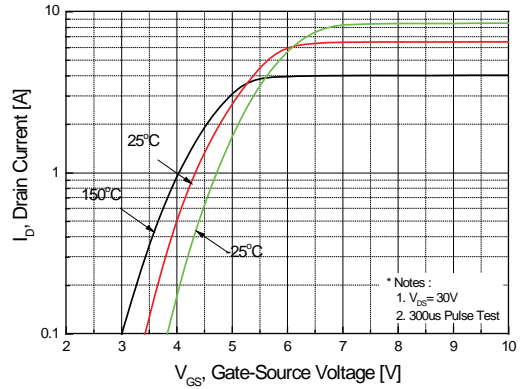


Figure 2. Transfer Characteristics

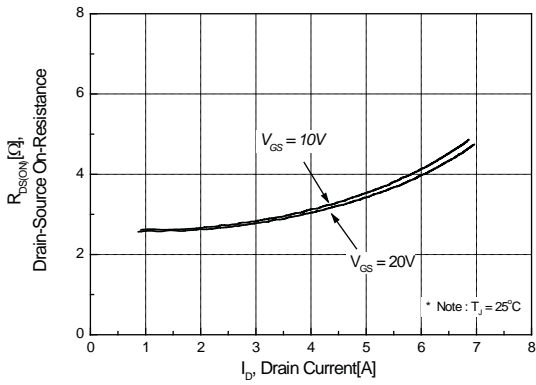


Figure 3. On Resistance Variation vs Drain Current and Gate Voltage

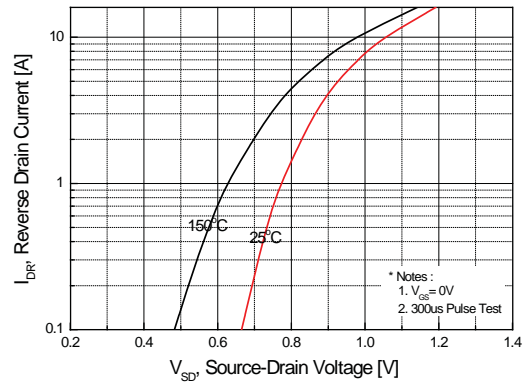


Figure 4. Body Diode Forward Voltage Variation with Source Current and Temperature

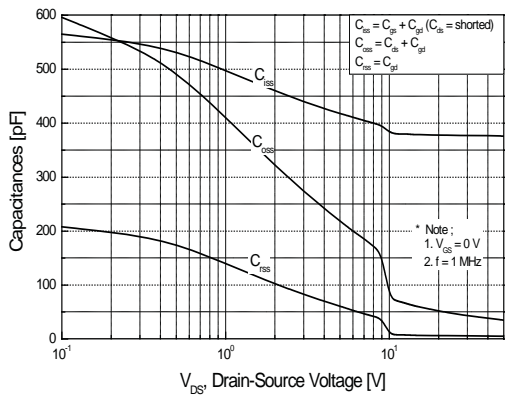


Figure 5. Capacitance Characteristics

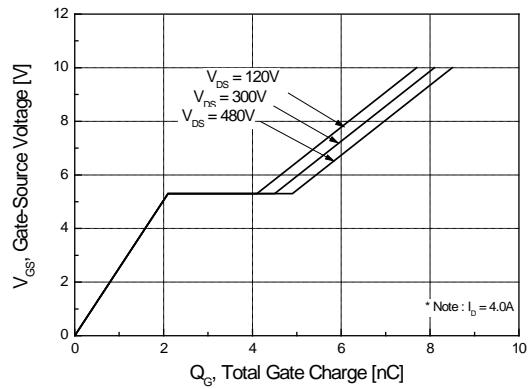


Figure 6. Gate Charge Characteristics

Typical Characteristics (continued)

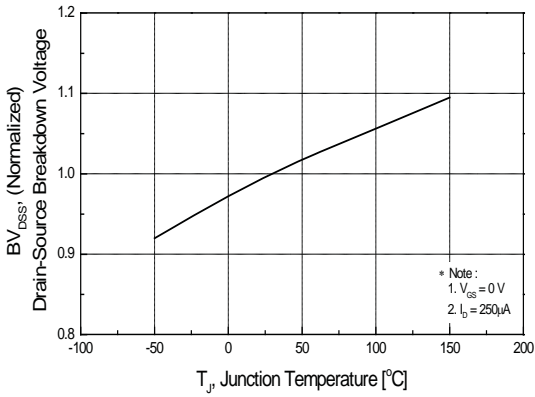


Figure 7. Breakdown Voltage Variation vs Temperature

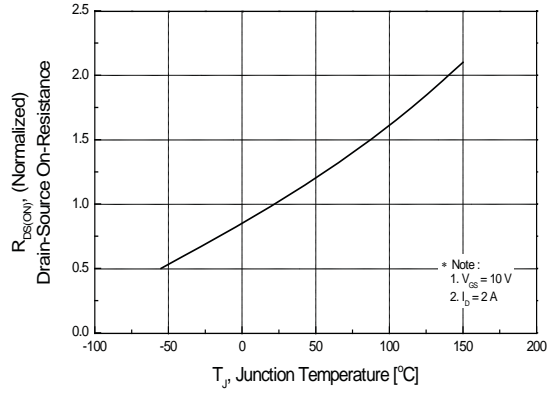


Figure 8. On-Resistance Variation vs Temperature

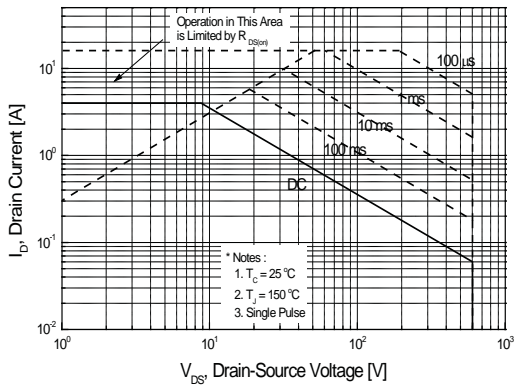


Figure 9. Maximum Safe Operating Area

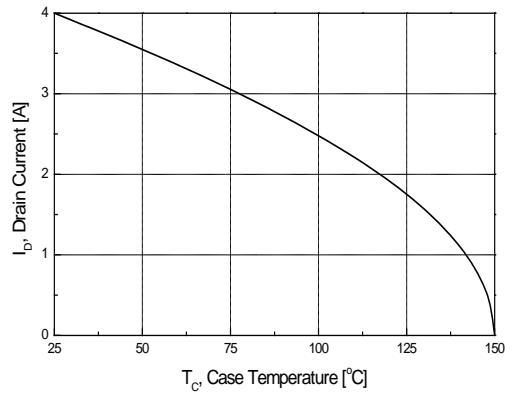


Figure 10. Maximum Drain Current vs Case Temperature

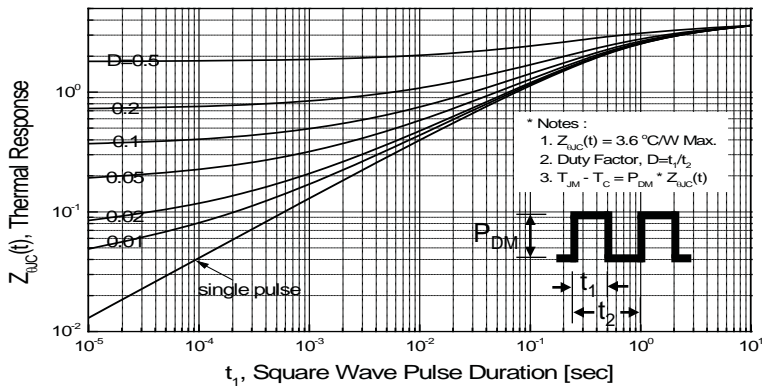


Figure 11. Transient Thermal Response Curve

Fig 12. Gate Charge Test Circuit & Waveform



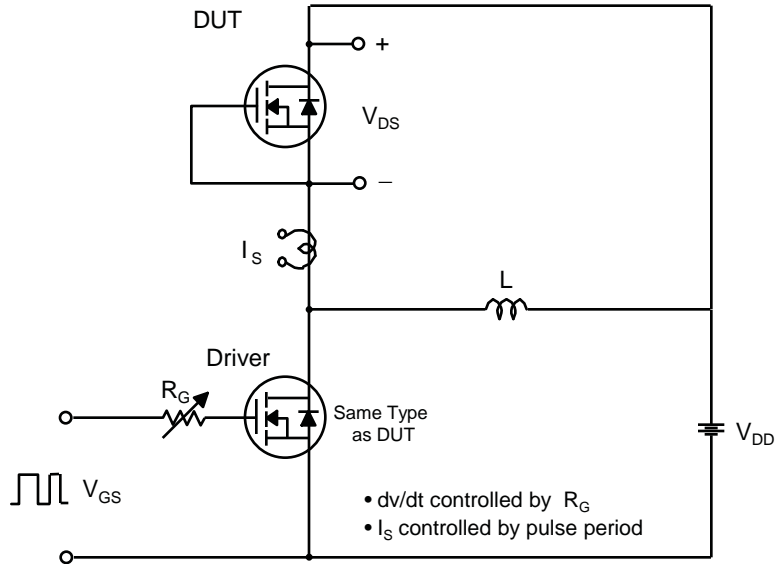
Fig 13. Resistive Switching Test Circuit & Waveforms



Fig 14. Unclamped Inductive Switching Test Circuit & Waveforms

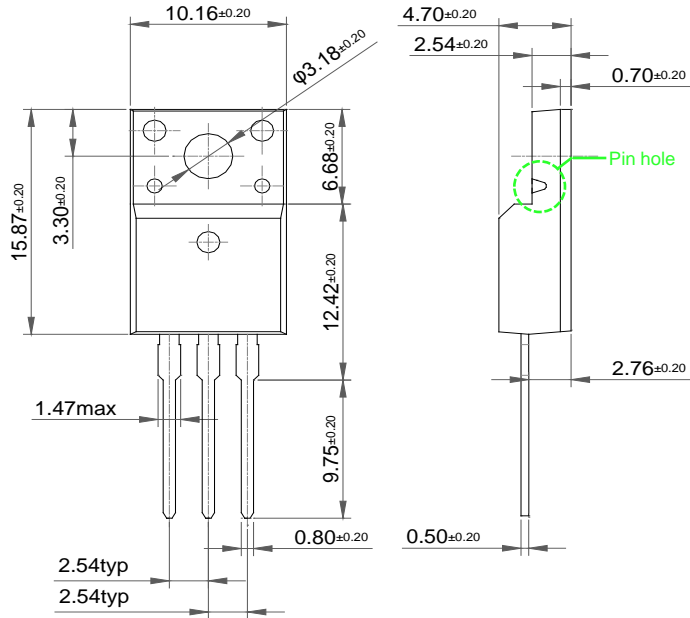


Fig 15. Peak Diode Recovery dv/dt Test Circuit & Waveforms



Package Dimension

TO-220FS



TO-220FS-FM(Full Mold)

