

HFC1N80

800V N-Channel MOSFET

FEATURES

- Originative New Design
- Superior Avalanche Rugged Technology
- Robust Gate Oxide Technology
- Very Low Intrinsic Capacitances
- Excellent Switching Characteristics
- Unrivalled Gate Charge : 7.5 nC (Typ.)
- Extended Safe Operating Area
- Lower $R_{DS(ON)}$: 13 Ω (Typ.) @ $V_{GS}=10V$
- 100% Avalanche Tested

$$BV_{DSS} = 800 \text{ V}$$

$$R_{DS(on) \text{ typ}} = 13 \Omega$$

$$I_D = 0.6 \text{ A}$$

TO-126



1.Gate 2. Drain 3. Source

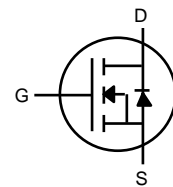

Absolute Maximum Ratings $T_C=25^\circ\text{C}$ unless otherwise specified

Symbol	Parameter	Value	Units
V_{DSS}	Drain-Source Voltage	800	V
I_D	Drain Current – Continuous ($T_C = 25^\circ\text{C}$)	0.6	A
	Drain Current – Continuous ($T_C = 100^\circ\text{C}$)	0.37	A
I_{DM}	Drain Current – Pulsed (Note 1)	2.4	A
V_{GS}	Gate-Source Voltage	± 30	V
E_{AS}	Single Pulsed Avalanche Energy (Note 2)	90	mJ
I_{AR}	Avalanche Current (Note 1)	0.6	A
E_{AR}	Repetitive Avalanche Energy (Note 1)	1.39	mJ
dv/dt	Peak Diode Recovery dv/dt (Note 3)	4.0	V/ns
P_D	Power Dissipation ($T_C = 25^\circ\text{C}$)	13.9	W
	– Derate above 25°C	0.11	W/ $^\circ\text{C}$
T_J, T_{STG}	Operating and Storage Temperature Range	-55 to +150	$^\circ\text{C}$
T_L	Maximum lead temperature for soldering purposes, 1/8" from case for 5 seconds	300	$^\circ\text{C}$

Thermal Resistance Characteristics

Symbol	Parameter	Typ.	Max.	Units
$R_{\theta JC}$	Junction-to-Case	--	9.0	$^\circ\text{C}/\text{W}$
$R_{\theta JA}$	Junction-to-Ambient	--	62.5	

Electrical Characteristics $T_C=25\text{ }^\circ\text{C}$ unless otherwise specified

Symbol	Parameter	Test Conditions	Min	Typ	Max	Units
On Characteristics						
V_{GS}	Gate Threshold Voltage	$V_{DS} = V_{GS}, I_D = 250\ \mu\text{A}$	2.5	--	4.5	V
$R_{DS(ON)}$	Static Drain-Source On-Resistance	$V_{GS} = 10\ \text{V}, I_D = 0.3\ \text{A}$	--	13	16	Ω

Off Characteristics

BV_{DSS}	Drain-Source Breakdown Voltage	$V_{GS} = 0\ \text{V}, I_D = 250\ \mu\text{A}$	800	--	--	V
$\Delta BV_{DSS}/\Delta T_J$	Breakdown Voltage Temperature Coefficient	$I_D = 250\ \mu\text{A}$, Referenced to $25\text{ }^\circ\text{C}$	--	1.0	--	$\text{V}/^\circ\text{C}$
I_{DSS}	Zero Gate Voltage Drain Current	$V_{DS} = 800\ \text{V}, V_{GS} = 0\ \text{V}$	--	--	1	μA
		$V_{DS} = 640\ \text{V}, T_C = 125\text{ }^\circ\text{C}$	--	--	10	μA
I_{GSSF}	Gate-Body Leakage Current, Forward	$V_{GS} = 30\ \text{V}, V_{DS} = 0\ \text{V}$	--	--	100	nA
I_{GSSR}	Gate-Body Leakage Current, Reverse	$V_{GS} = -30\ \text{V}, V_{DS} = 0\ \text{V}$	--	--	-100	nA

Dynamic Characteristics

C_{iss}	Input Capacitance	$V_{DS} = 25\ \text{V}, V_{GS} = 0\ \text{V},$ $f = 1.0\ \text{MHz}$	--	150	195	pF
C_{oss}	Output Capacitance		--	20	26	pF
C_{rss}	Reverse Transfer Capacitance		--	5.5	7.2	pF

Switching Characteristics

$t_{d(on)}$	Turn-On Time	$V_{DS} = 400\ \text{V}, I_D = 1.0\ \text{A},$ $R_G = 25\ \Omega$	--	12	30	ns	
t_r	Turn-On Rise Time		--	40	90	ns	
$t_{d(off)}$	Turn-Off Delay Time		(Note 4,5)	--	25	60	ns
t_f	Turn-Off Fall Time			--	45	100	ns
Q_g	Total Gate Charge	$V_{DS} = 640\ \text{V}, I_D = 1.0\ \text{A},$ $V_{GS} = 10\ \text{V}$	--	7.5	10.0	nC	
Q_{gs}	Gate-Source Charge		(Note 4,5)	--	1.2	--	nC
Q_{gd}	Gate-Drain Charge			--	4.5	--	nC

Source-Drain Diode Maximum Ratings and Characteristics

I_S	Continuous Source-Drain Diode Forward Current	--	--	0.6	A	
I_{SM}	Pulsed Source-Drain Diode Forward Current	--	--	2.4		
V_{SD}	Source-Drain Diode Forward Voltage	$I_S = 0.6\ \text{A}, V_{GS} = 0\ \text{V}$	--	--	1.4	V
t_{rr}	Reverse Recovery Time	$I_S = 1.0\ \text{A}, V_{GS} = 0\ \text{V}$	--	310	--	ns
Q_{rr}	Reverse Recovery Charge	$di_F/dt = 100\ \text{A}/\mu\text{s}$ (Note 4)	--	0.8	--	μC

Notes ;

1. Repetitive Rating : Pulse width limited by maximum junction temperature
2. $L=170\text{mH}, I_{AS}=1.0\text{A}, V_{DD}=50\text{V}, R_G=25\Omega$, Starting $T_J=25\text{ }^\circ\text{C}$
3. $I_{SD}\leq 0.6\text{A}, di/dt\leq 200\text{A}/\mu\text{s}, V_{DD}\leq BV_{DSS}$, Starting $T_J=25\text{ }^\circ\text{C}$
4. Pulse Test : Pulse Width $\leq 300\mu\text{s}$, Duty Cycle $\leq 2\%$
5. Essentially Independent of Operating Temperature

Typical Characteristics

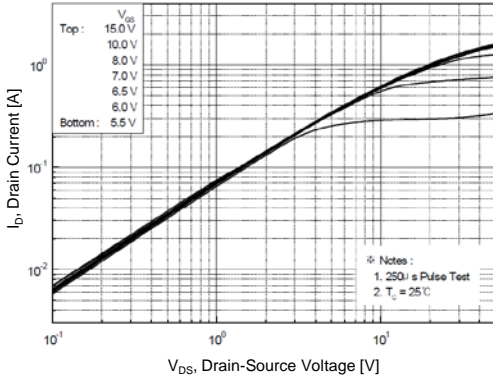

Figure 1. On Region Characteristics

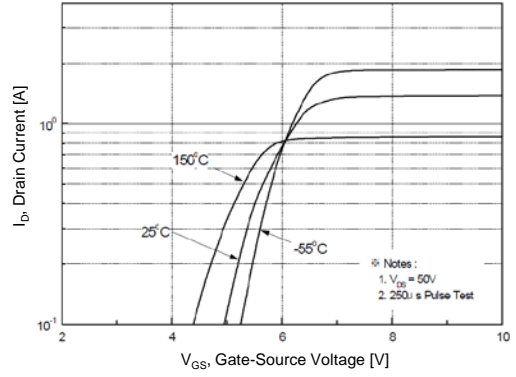

Figure 2. Transfer Characteristics

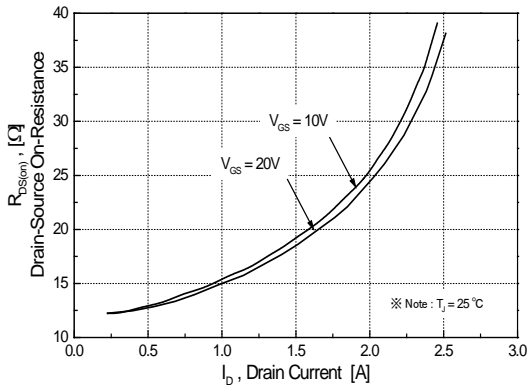

Figure 3. On Resistance Variation vs Drain Current and Gate Voltage

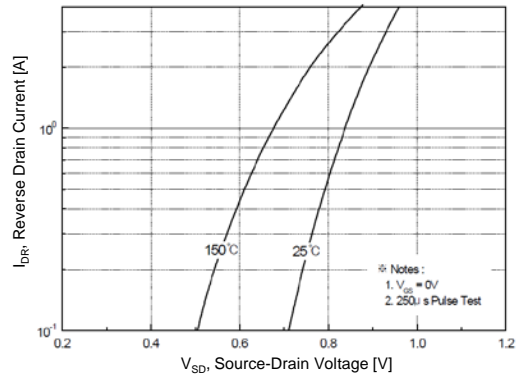

Figure 4. Body Diode Forward Voltage Variation with Source Current and Temperature

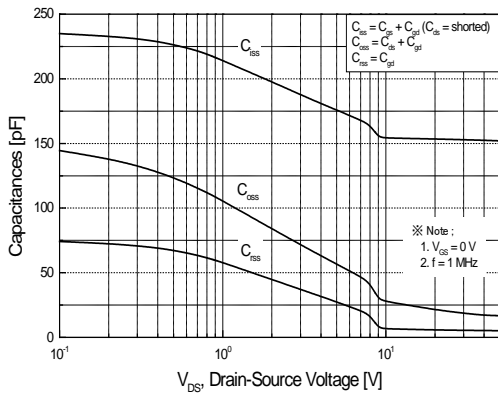

Figure 5. Capacitance Characteristics

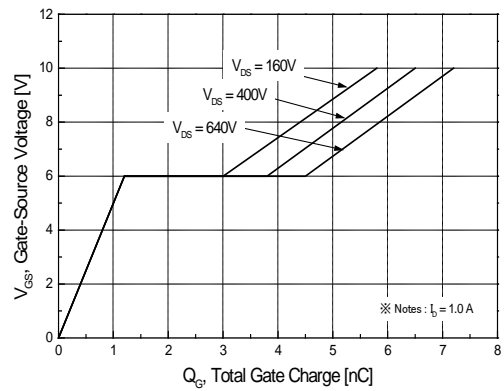

Figure 6. Gate Charge Characteristics

Typical Characteristics (continued)

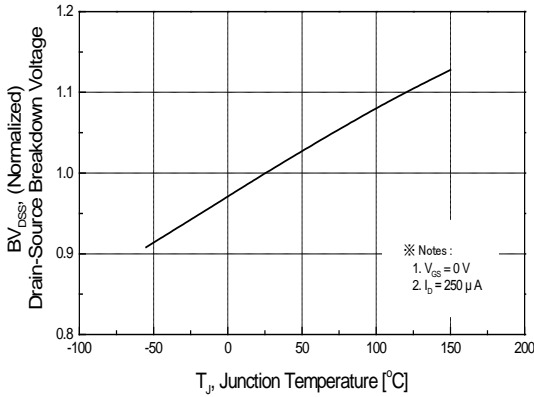

Figure 7. Breakdown Voltage Variation vs Temperature

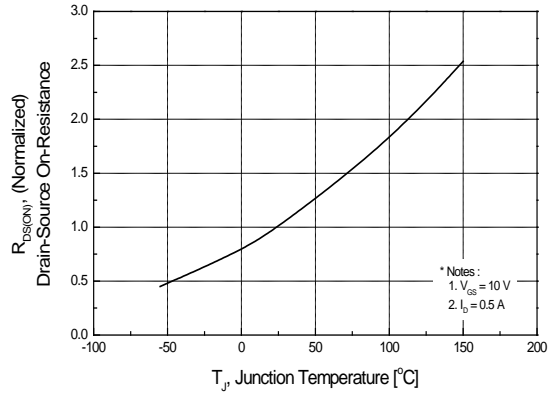

Figure 8. On-Resistance Variation vs Temperature

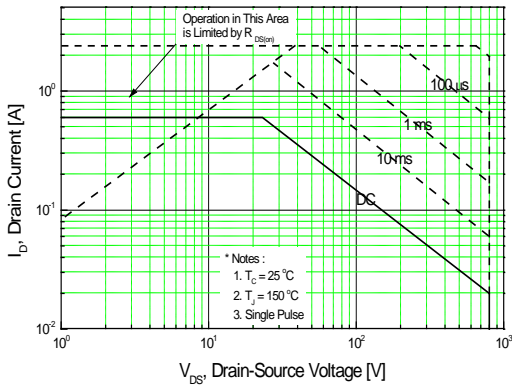

Figure 9. Maximum Safe Operating Area

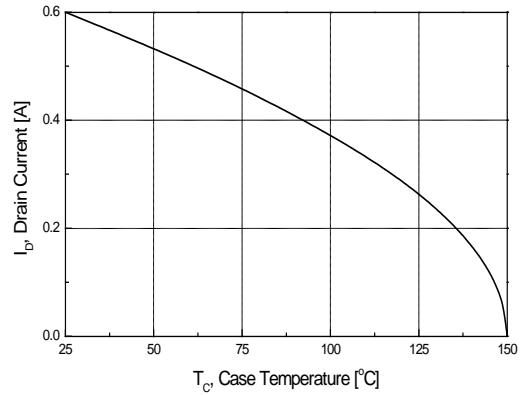

Figure 10. Maximum Drain Current vs Case Temperature

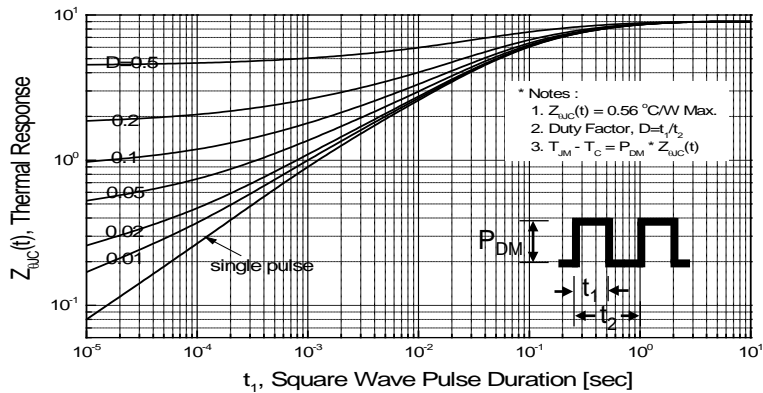

Figure 11. Transient Thermal Response Curve

Fig 12. Gate Charge Test Circuit & Waveform



Fig 13. Resistive Switching Test Circuit & Waveforms

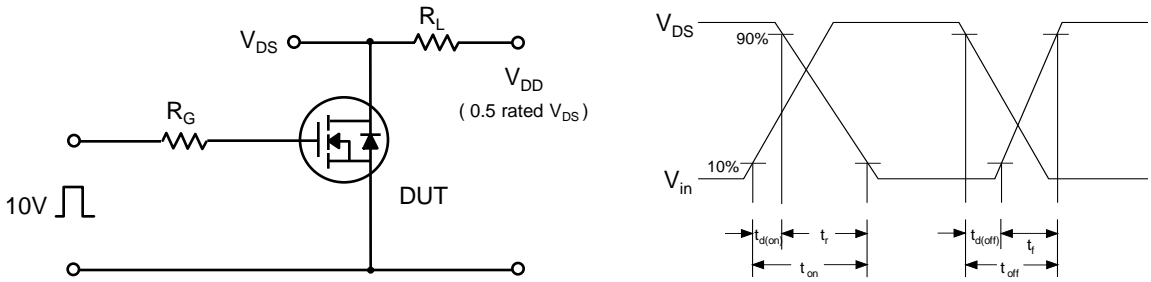

Fig 14. Unclamped Inductive Switching Test Circuit & Waveforms

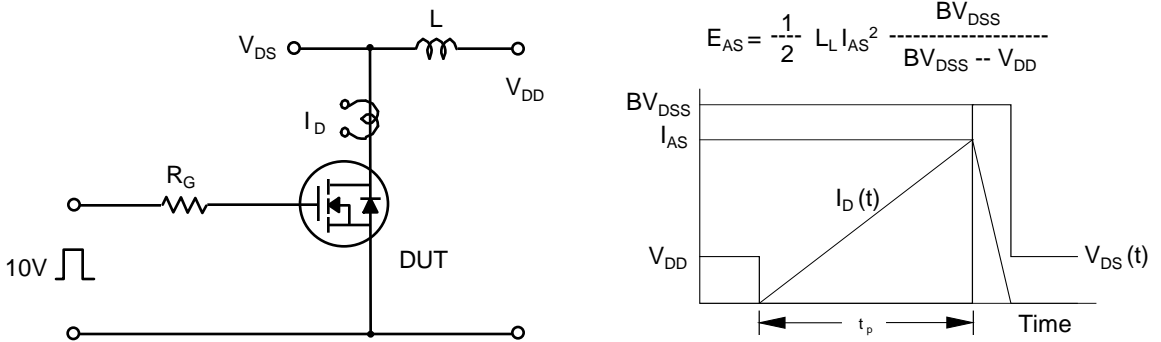
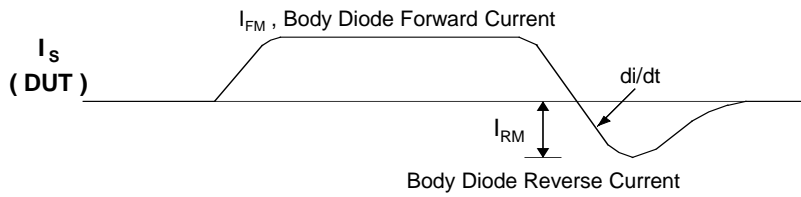

Fig 15. Peak Diode Recovery dv/dt Test Circuit & Waveforms



Package Dimension

TO-126

